

Area Sensor

# PAN series

INSTRUCTION MANUAL

Thank you for purchasing Hanyoung Nux products.  
Please read the instruction manual carefully before using this product, and use the product correctly.  
Also, please keep this instruction manual where you can see it at any time.

HANYOUNG NUX



HANYOUNGNEXCO.,LTD

28, Gilpa-ro 71beon-gil, Michuhol-gu, Incheon, Korea  
TEL : +82-32-876-4697  
http://www.hynux.com

MK0603KE190626

## Safety information

Please read the safety information carefully before use, and use the product correctly.  
The alerts declared in the manual are classified into **Danger**, **Warning** and **Caution** according to their importance

<b>DANGER</b>	Indicates an imminently hazardous situation which, if not avoided, will result in death or serious injury
<b>WARNING</b>	Indicates a potentially hazardous situation which, if not avoided, could result in death or serious injury
<b>CAUTION</b>	Indicates a potentially hazardous situation which, if not avoided, may result in minor injury or property damage

### DANGER

- The input/output terminals are subject to electric shock risk. Never let the input/output terminals come in contact with your body or conductive substances.

### WARNING

- The contents of this manual are subject to change without prior notice.
- To prevent deflection or malfunction of this product, supply proper power voltage in accordance with the rating.
- Do not use the product at where subject to flammable or explosive gas.
- Remove this product while the power is off. Otherwise, it may cause malfunction or electric shock.
- Due to the danger of electric shock, use this product installed onto a panel while an electric current is applied.
- To avoid electric shock, use this product installed on the panel.
- This product is not for press safety sensors.
- This product does not have control of the disaster prevention and accident prevention.
- Hanyoung Nux shall not be liable for a damage and for a failure.

### CAUTION

- The contents of this manual are subject to change without prior notification.
- If you use the product with methods other than specified by the manufacturer, there may be bodily injuries or property damages.
- Do not decompose, modify, revise or repair this product. This may be a cause of malfunction, electric shock or fire.
- Make sure that there is no damage or abnormality of the product during delivery.
- Do not use this product at any place with a large inductive noise or occurring static electricity or magnetic noise.
- Do not use this product at any place with possible thermal accumulation from direct sunlight or heat radiation.
- When the product gets wet, the inspection must be done to avoid electric leakage or fire.
- Make sure that the unused wire insulated.
- Make sure to wire with correct polarity of terminals.
- For the continuous and safe use of this product, the periodical maintenance is recommended.
- Make wiring as short as possible, wire is recommended with its dimension 0.5 mm or more and maximum 25m.
- Avoid continuously switching the power source On and Off.
- Use a dry cloth to wipe off the substance when cleaning the lens or cases. Never use thinner or organic solvents.
- Do not use this product where exposed to dust, vibration or impact.
- Before inserting power source, make sure that the circuit wiring is properly connected.
- In the case of wiring loaded inductors such as DC Relay and others to output, use diode, varistor and others to prevent surge.
- To avoid malfunction caused by noise, do not put high voltage or power line with sensor wire in a same conduit
- Prevent strong disturbance light such as sunlight and others which directly enter into the directional angle of the sensor by putting a glare shield.
- When using the Switching Power Supply as the power source, earth the Frame Ground (F.G) terminal and be sure to connect the noise-eliminating condenser between 0V and F.G.

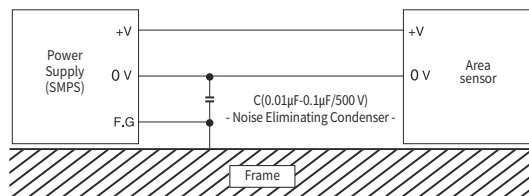

※ If you do not follow the contents described in the safety information then it is possible to be a cause of the product's malfunction so please follow them.

## Feature

- Minimum beam pitch 20 mm, maximum beam pitch 40 mm.
- Providing various detection range (140mm - 940mm).
- Mutual interference protection when installed in parallel (Max 2 sets).
- Dark On/ light ON operation selectable according to applications.
- Easy to check and maintenance by operation display and Error indicator.

## Suffix code

Model	Code	Content
PAN	□ □ □ □	Area Sensor
Optical axis pitch	20	20 mm
	40	40 mm
Sensing method	T	Through Beam
Number of optical axis		Number of optical axis (Please refer to table below)
Control output	N	NPN open collector
	P	PNP open collector

### Number of optical axis

Model	Number of optical axis
PAN20	8, 12, 16, 20, 24, 28, 32, 36, 40, 44, 48
PAN40	4, 6, 8, 10, 12, 14, 16, 18, 20, 22, 24

## Specification

Type	Through beam	
Model	NPN	PAN20-T□N
	PNP	PAN20-T□P
Sensing distance	7 m	
Sensing object	Opaque object over Ø32 mm	Opaque object over Ø52 mm
Optical axis pitch	20 mm	40 mm
Light source	IR (860nm)	
Power voltage	12 - 24 VDC ±10% Ripple(p-p)10% max	
Current consumption	Max. 170 mA	Max. 100 mA
Control output	<ul style="list-style-type: none"> <li>NPN / PNP open collector output</li> <li>Load Current: Max. 100mA (26.4VDC standard)</li> <li>Residual voltage - NPN: Max. 1 V, PNP:Max. 1 V</li> </ul>	
Operation mode	Transmitter - M/S MODE switch-return type (Master / Slave) Receiver - D/L MODE switch-return type (Dark ON / Light ON)	
Operation LED	Transmitter : Power indicator(Green LED), M/S display(Red LED) Receiver : Light on stability display(Green LED), output Display(Red LED), E1 display(Red LED), E2 display(Blue LED)	
Protection circuit	Power reverse connection protection, Output short-circuit over-current protection, Mutual interference prevention function	
Response Time	Max. 15 ms	
Insulation resistance	Min. 20 MΩ (500 VDC mega standard)	
Noise immunity	Square wave noise by noise simulator (pulse width 1 μs) ±240 V	
Dielectric strength	1,000 VAC (50/60 Hz 1min)	
Vibration resistance	10 - 55 Hz, double amplitude: 1.5 mm, X-Y-Z in each direction for 2 hours	
Shock resistance	500m/s <sup>2</sup> , X-Y-Z each direction 3 times	
Ambient illumination	Sunlight : Max. 10,000 Lux, Incandescent lamp : Max. 3,000 Lux	
Ambient temperature	During operation : -10 ~ +55 °C, During storage : -25 ~ +70 °C (Without condensation or icing)	
Ambient humidity	35 ~ 85 % R.H. (Without condensation)	
Degree of protection	IP65 (IEC standard)	
Approval	CE	
Connection method	Relay connector type (Code length : 200 mm, Number of wires : 4P, Dimension : Ø5.5 mm)	
Material	Case	Aluminum
	front cover	Acryl
	lens	Acryl

• Please note that the response speed may vary depending on the size, surface condition, and glossiness of the object to be detected.

## Production formation

Series	Model	Detection	Sensing Distance	Number of optical axes	Detecting	Current Consumption (mA max)	Detectable object
PAN20	PAN20-T8	Through Beam	7 m	8 EA	140 mm	70 mA	Opaque object above Ø32 mm
	PAN20-T12			12 EA	220 mm	80 mA	
	PAN20-T16			16 EA	300 mm	90 mA	
	PAN20-T20			20 EA	380 mm	100 mA	
	PAN20-T24			24 EA	460 mm	110 mA	
	PAN20-T28			28 EA	540 mm	120 mA	
	PAN20-T32			32 EA	620 mm	130 mA	
	PAN20-T36			36 EA	700 mm	140 mA	
	PAN20-T40			40 EA	780 mm	150 mA	
	PAN20-T44			44 EA	860 mm	160 mA	
	PAN20-T48			48 EA	940 mm	170 mA	
	PAN40			PAN40-T4	Through Beam	7 m	
PAN40-T6		6 EA	200 mm	55 mA			
PAN40-T8		8 EA	280 mm	60 mA			
PAN40-T10		10 EA	360 mm	65 mA			
PAN40-T12		12 EA	440 mm	70 mA			
PAN40-T14		14 EA	520 mm	75 mA			
PAN40-T16		16 EA	600 mm	80 mA			
PAN40-T18		18 EA	680 mm	85 mA			
PAN40-T20		20 EA	760 mm	90 mA			
PAN40-T22		22 EA	840 mm	95 mA			
PAN40-T24		24 EA	920 mm	100 mA			

• Output types (NPN, PNP) are omitted.

## Output Circuit

### NPN Open Collector Output (N TYPE)

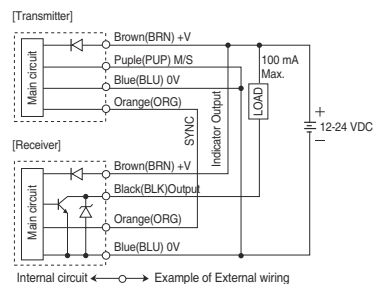

### PNP Open Collector Output (P TYPE)

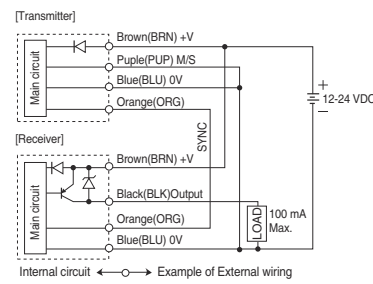

## Dimension

### PAN20 series

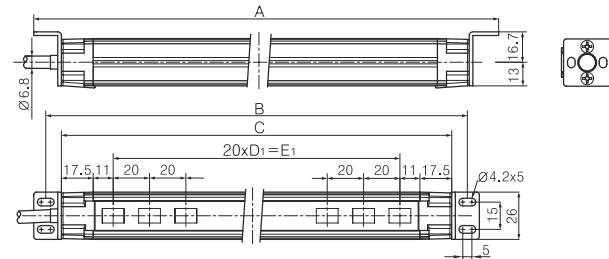

### PAN40 series

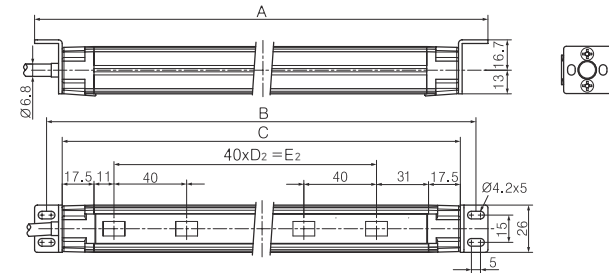

[Unit: mm]

Type	A	B	C	D <sub>1</sub>	D <sub>2</sub>	E <sub>1</sub>	E <sub>2</sub>	
PAN20-T8	PAN40-T4	227	214.2	197	7	3	140	120
PAN20-T12	PAN40-T6	307	294.2	277	11	5	220	200
PAN20-T16	PAN40-T8	387	374.2	357	15	7	300	280
PAN20-T20	PAN40-T10	467	454.2	437	19	9	380	360
PAN20-T24	PAN40-T12	547	534.2	517	23	11	460	440
PAN20-T28	PAN40-T14	627	614.2	597	27	13	540	520
PAN20-T32	PAN40-T16	707	694.2	677	31	15	620	600
PAN20-T36	PAN40-T18	787	774.2	757	35	17	700	680
PAN20-T40	PAN40-T20	867	854.2	837	39	19	780	760
PAN20-T44	PAN40-T22	947	934.2	917	43	21	860	840
PAN20-T48	PAN40-T24	1027	1014.2	997	47	23	940	920

## Indicator & Wiring classification

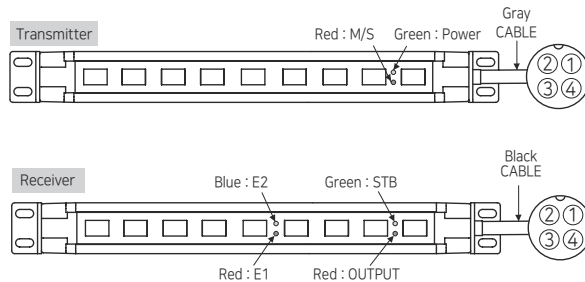

### Operation LED classification

LED indicator	Transmitter
Red	L.OFF when operation the MASTER / L.ON when operating the SLAVE
Green	Power indicator

LED indicator	Receiver
Red	Operation LED
Green	L.ON stability indicator
Red	L.OFF with the disconnection or break of cluck (sync signal)/reset signal wire
Blue	L.OFF with the appearance of disturbance light such as mercury lamp, luminescent light and etc.

### Wiring and connecting classification

PIN NO.	Wiring color	Transmitter
1	Brown	Power (12 - 24 VDC)
2	Orange	Sync wire
3	Blue	GND
4	Purple	M/S

PIN NO.	Wiring color	Receiver
1	Brown	Power (12 - 24 VDC)
2	Orange	Sync wire
3	Blue	GND
4	Black	Output

## Operation chart

Operation Mode	Detection status	Safety region operation region
Light ON	Operation indicator (Red LED)	ON OFF
	Control output	ON OFF
	Stable indicator (Green LED)	ON OFF
	Disturbance light	ON OFF
	E2 indicator (Blue LED)	ON OFF

- Green LED on the Transmitter is power indication.
- The E1 indicator on the receiver (red led) is turn off when the sync line is shorted.
- The E2 indicator on the receiver (blue LED) is turn off when there is a disturbance light such as sunlight, fluorescent light, etc. (It may malfunction when the E2 indicator is turn off so please be careful)
- In the case of Dark On, the operation indicator and control output operate in the reverse direction of Light ON.

## MASTER / SLAVE Connection diagram

- When two sensors are used close together, set them as shown below. Connect sensor A and sensor B according to the connection method in <Image 1>.

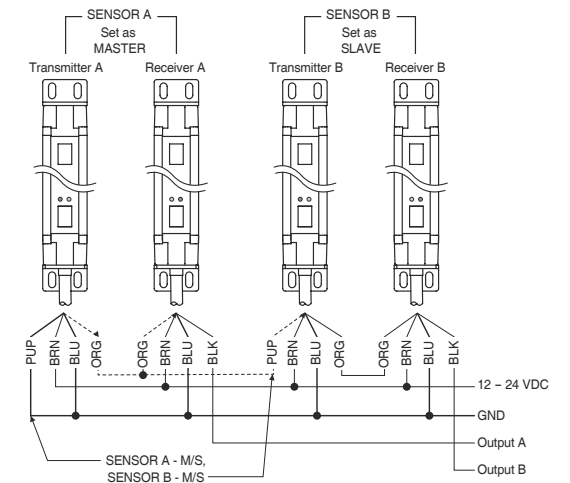

<Image 1>

- Open the connector cover at the bottom of the Transmitter (use the flat drive) and make the operation mode conversion switch as shown in Image 2 below. Set the Transmitter of sensor A to M (Master) and the Transmitter of sensor B to S (Slave)
- Default = M (Master)

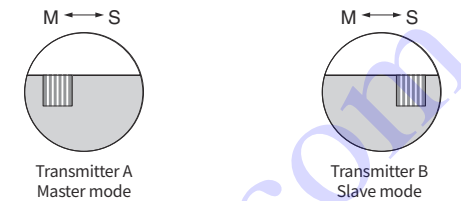

<Image 2>

- When using two sets of sensors together, wire them so that they do not become the master operation mode or the slave operation mode for both of them.
- Do not connect the sync lines of sensor A and sensor B to each other.
- Check the M / S indicator of the Transmitter after turning on the power.  
Transmitter A (Master operation mode): M/S indicator is Turn off,  
Transmitter B (Slave operation mode): M/S indicator is Turn on.

## Operation Mode

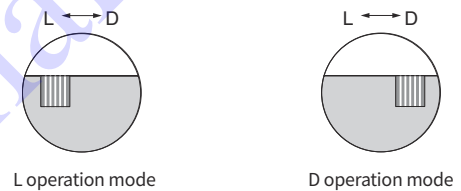

<Image 3>

- Open the connector cover at the bottom of the Transmitter (use the flat drive), and use the operation mode switch to select the mode that meets the operating conditions.
- Default mode: L (Light ON) operation mode  
L: LIGHT ON / D: DARK ON

## Mounting and optical axis adjustment

- After checking the connection status, turn on the power and check that the power indicator (green) of the Transmitter is turn on.
- Move the Transmitter up, down, left, and right so that the light stability indicator (green) of the Receiver turns on.