

Digital counter & timer

GE series

INSTRUCTION MANUAL

Thank you for purchasing HANYOUNG product.
Please check whether the product is the exactly same as you ordered.
Before using the product, please read this instruction manual carefully.
Please keep this manual where you can view at any time



HANYOUNG NUX CO., LTD
1381-3, Juan-Dong, Nam-Gu Incheon, Korea.
TEL:(82-32)876-4697 FAX:(82-32)876-4696 <http://www.hynux.net>

PT. HANYOUNG ELECTRONIC INDONESIA
JL.CEMPAKA BLOK F 16 NO.02 DELTA SILICON II INDUSTRIAL PARK
LIPPO CIKARANG CICAU, CIKARANG PUSAT BEKASI 17550 INDONESIA
TEL : 62-21-8911-8120~4 FAX : 62-21-8911-8126

Safety information

Before using the product, please read the safety information thoroughly and use it properly.
Alerts declared in the manual are classified to Danger, Warning and Caution by their criticality.

	DANGER	DANGER indicates an imminently hazardous situation which, if not avoided, will result in death or serious injury
	WARNING	WARNING indicates a potentially hazardous situation which, if not avoided, could result in death or serious injury
	CAUTION	CAUTION indicates a potentially hazardous situation which, if not avoided, may result in minor or moderate injury

DANGER

Do not touch or contact the input/output terminals because it may cause electric shock.

WARNING

- If the user use the product with methods other than specified by the manufacturer, there may be bodily injuries or property damages.
- If there is a possibility of an accident caused by errors or malfunctions of this product, install external protection circuit to prevent the accident.
- Since this product does not have the power switch or a fuse, please install those separately on the outside. (Fuse rating: 250V 0.5A)
- To prevent damage or failure of this product, please supply the rated power voltage.
- To prevent electric shock or equipment failure, please do not turn on the power until completing wiring.
- Since this is not explosion-proof structure, please do not use in a place where combustible or explosive gas is around.
- Never disassemble, modify, or repair the product. There is a possibility of a malfunction, an electric shock, or a risk of fire.
- Please turn off the power when mounting/dismounting of the product. This is a cause of an electric shock, a malfunction, or failure.
- Since there is a possibility of an electric shock, please use the product as mounted on a panel while the power is being supplied.

CAUTION

- The contents of the instruction manual are subjective to change without prior notice.
- Please make sure that the specification is the same as what you have ordered.
- Please make sure that the product is not damaged during shipping.
- Please use this product in a place where corrosive gas (such as harmful gas, ammonia, etc.) and flammable gas do not occur.
- Please use this product in a place where there is no direct vibration and a large physical impact to the product.
- Please use this product in a place where there is no water, oil, chemicals, steam, dust, salt, iron or others (Contamination class 1 or 2).
- Please do not wipe this product with organic solvents such as alcohol, benzene and others. (Please use mild detergent)
- Please avoid places where excessive amounts of inductive interference and electrostatic and magnetic noise occur.
- Please avoid places where heat accumulation occurs due to direct sunlight or radiant heat.
- Please use this product in a place where the elevation is below 2,000 m.
- Please make sure to inspect the product if exposed to water since there is a possibility of an electric leakage or a risk of fire.
- If there is a lot of noise from the power line, installing an insulated transformer or a noise filter is recommended. The noise filter should be grounded on the panel and the lead wire between the output of the noise filter and the power terminal of the instrument should be as short as possible.
- It is effective against noise if making the power lines of the product the twisted pair wiring.
- Please do not connect anything to the unused terminals.
- Please connect wires properly after making sure the polarity of terminal.
- Please use a switch or breaker (IEC60947-1 or IEC60947-3 approved) when the product is mounted on a panel.
- Please install a switch or break near the operator to facilitate its operation.
- In order to use this product properly and safely, we recommend periodic maintenance.
- Some parts of this product have limited expected life span and aged deterioration.

- The warranty of this product (including accessories) is 1 year only when it is used for the purpose it was intended under normal condition.
- When the power is being supplied there should be a preparation time for the contact output. Please use a delay relay together when it is used as a signal on the outside of interlock circuit or others.

Suffix code

Model	Code	Description
GE	□-□□□□	Digital counter & timer
Appearance	3	96(W) × 48(H) mm
	4	48(W) × 48(H) mm
	6	72(W) × 36(H) mm
	7	72(W) × 72(H) mm
Type	P	Preset counter
	T	Total counter (Only for indication)
Displayable digit	4	4 digits (9999) *GE3 and GE7 are not selectable
	6	6 digits (999999)
Setting stage (excludes the total counter)	1	1 Stage setting
	2	2 Stage setting
Power supply voltage	A	100 - 240 V a.c 50 - 60 Hz
	D	24 - 60 V d.c / a.c 50 - 60 Hz

Specification

Model	GE4	GE6	GE3	GE7	
Power supply voltage	100 - 240 V a.c 50 - 60 Hz, 24 - 60 V d.c/a.c (voltage fluctuation : ±10 %)				
Power consumption	Approx. 13.5 VA(100 - 240 V a.c), approx. 5 W(24 - 60 V d.c), Approx. 9 VA(24 - 60 V a.c)				
Charater height(mm)	11 (computed), 8 (set value)		13 (computed), 10 (set value)		
Input counting speed	1 cps, 30 cps, 1 kcps, 10 kcps (ON/OFF ratio : 1:1, "H" level : 5 - 3 V d.c, "L" level : 0 - 2 V d.c)				
Memory back-up	10 years (non-volatile memory)				
Input	CP1, CP2, RESET, BATCH RESET (exclude TOTAL) 4inputs [H] level 4 - 30 V d.c, [L] level 0 - 2 V d.c Internal pull up/pull down resistance connection due to NPN/PNP setup				
Min input signal	Counter	External reset Min. input signal range : select among 0.1 ms, 1 ms, 20 ms			
	Timer	START, INHIBIT, RESET Min. input signal range : select either 1 ms, 20 ms			
External supplying power	12 V d.c 100 mA max				
ONE SHOT output	0.01 - 99.99 s [OUT1, OUT2(OUT)]				
Control output	Contact	1 st level	1c (OUT)	1a (OUT)	1c (OUT)
		2 nd level	1a (OUT1), 1c (OUT2)		
	capacity	a contact : 250 V a.c 3 A (resistive load), b contact : 250 V a.c 2 A			
	Non-contact	1 st level	NPN 2contacts (OUT, BAT.O)		
2 nd level		-	-	NPN 2 contact (OUT1, OUT2)	
	capacity	Open collector, 30 V d.c, 100 mA max			
Timer action error	With power start : ±0.01 % ±0.05 sec max With reset start : ±0.005 % ±0.003 sec max				
Insulation resistance	100 MΩ min (500 V d.c) Between current-carrying terminals and exposed non-current-carrying metal parts.				
Dielectric strenght	2000 V a.c 60 Hz for 1 min (differerent recharging terminal from each other)				
Noise resistance	Square wave by the nois simulator (1 μs pulse per 16 ms) ±2 kV (Power supply terminal), ±500 V (Input terminal)				
Vibration resistance	10 - 55 Hz, peak amplitude 0.5 mm, 3 axis each direction for 2 hour				
Shock resistance	300 %, 3 axis each three times				
Relay life	Electrical	100 thousand times min (250 V a.c 2 A resistance load)			
	Mechanical	1 million times min			
Protection structure	IP65 (Front part only)				
Storage temperature	-20 °C ~ 65 °C				
Ambient temperature humidity	-10 °C ~ 55 °C, 35 % ~ 85 % RH				
Weight	133 g max	138 g max	203 g max	203 g max	

* If you want to input and output type, please contact HANYOUNG sales office

Power supply

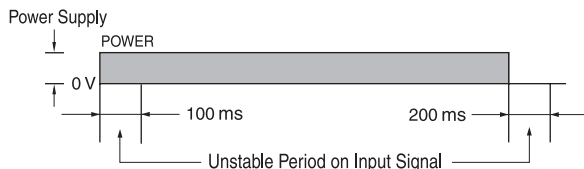

During the first 100 ms after power input and first 200 ms after power opening, it is consider as ascend and descend time of internal power and external output power. Therefore, it does not operate during unstable period in order to prevent from malfunction which is caused by unstable output operation of external sensor

- * Supply signal only after 100 ms following the power input.
- * Supply power only after 200 ms following the power shutdown.

Part name and functions

GE3

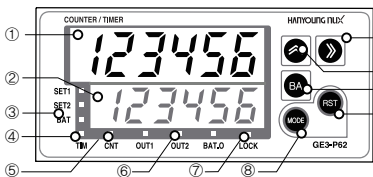

GE6

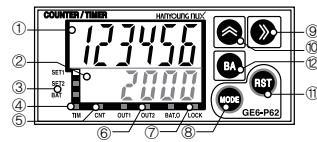

GE4

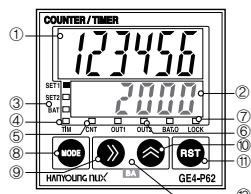

GE7

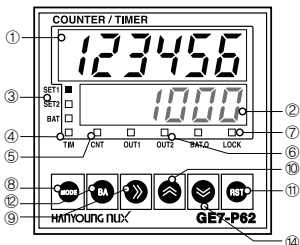

- Coefficient display (RED FND)**
Display coefficient value (counter), time process value (timer), batch coefficient value and setup list.
- Setup display (GREEN FND)**
Display setup value (counter), setup time (timer), batch setup value, instant output setup (batch setup is 0 in Timer) and setup contents
- SET1, SET2 (SET), BAT**
Indicates the status of coefficient section and setup section (BAT lamp corresponds to batch status.)
- TIM (Timer)**
This flashes when the timer progresses and remains lighted when the device stops from inhibit input or reset.
(It is indicated in Change Mode of the device during TIM/TTWIN setup.)
- CNT (Counter)**
This is indicated during 1CNT/2CNT setup in Change Mode of the device.
- OUT1, OUT2(OUT), BAT.O (Output Action Indication)**
• BAT.O lights up when the batch setup value is set. (OUT1 Output)
• BAT.O lights up and outputs when the device operates with the instant output where the batch setup value is 0 (timer).
• CP1, CP2, RST : Verification of Input Status. (Exclusively for TOTAL)
- LOCK:Key Lock (KEY LOCK) Action Indication**This lights up during Lock Setup.
- MD**: This key is for function setup Mode Entry and Mode change. It can also be used for ending after saving when changing the setup value
- MD**: Setup value change Entry and Location shift
- UP** Key
- RST**: RESET KEY ③When SET, BAT lamp light, RESET key will not operate.
- BA**: Batch and operation mode 1 stage and 2 stage conversion key. When BAT lamp light, it is batch mode and keep operate.
- +MD**: Push both of keys together, It operate same as **MD** key.
- DOWN** Key

* TOTAL Model does not have Setup Indication Section, SET1, SET2 and BAT Lamp. OUT1, OUT2, BAT.O change their use as CP1, CP2, RST Input Status Check Lamp. 1 Stage Setup Model does not have SET1 and OUT1 Lamp, and SET2 is displayed as SET and OUT2 is displayed as OUT.

Maximum coefficient speed

Maximum coefficient speed is maximum response speed when entering in the duty ratio (ON. OFF ratio) of coefficient input signal as one to one ratio (1:1)

- As for the input signal below the maximum coefficient speed, if either ON or OFF time is unilaterally less than the standard value of minimum signal width then it may not be counted
- Minimum Input Time

Coefficient Speed Selection	Minimum Input Signal
1 cps	250 ms
30 cps	11 ms
1 K cps	0.3 ms
10 K cps	0.05 ms

* Minimum Signal Time refers to 'ON' Time.



Counter mode setting method

(1st level setting type)

(2nd level setting type)

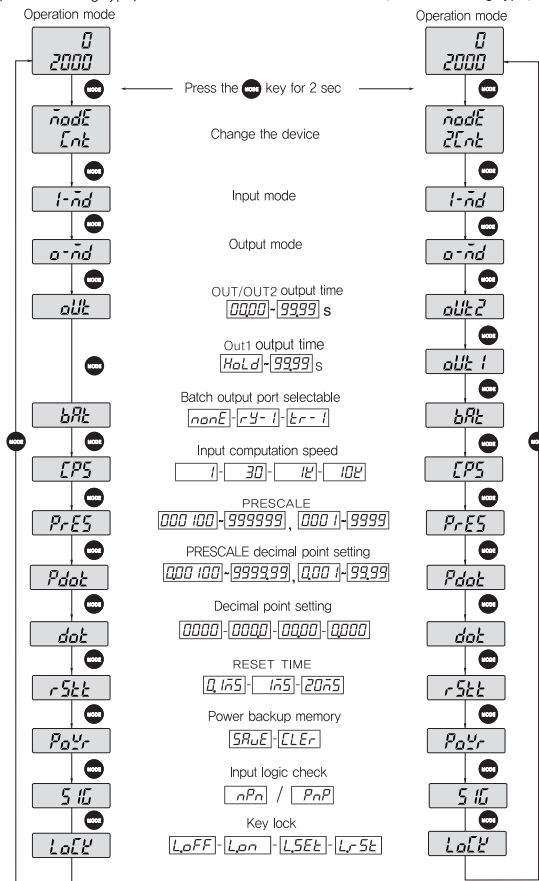

Counter function setting mode

Pressing the "MD" key in the operation mode for 2sec will set the function setting mode (■: Default set value)

Setting lists	Setting information	
Device change	1st level setting type $\overline{L}nE$ - $\overline{C}nt$ 2nd level setting type $\overline{L}nE$ - $\overline{L}nE$ - $\overline{2}Cnt$	1st level setting counter $\overline{C}Cnt$ 2nd level setting counter $\overline{2}Cnt$
Input mode	$\overline{U}A$ - $\overline{d}A$ $\overline{U}b$ - $\overline{d}b$ $\overline{U}Ab$ - $\overline{d}Ab$ $\overline{U}dA$ - $\overline{U}dB$ $\overline{U}dC$ - $\overline{U}dD$ $\overline{U}dE$ - $\overline{U}dF$	$\overline{U}Ab$: CP1, CP2 Individual input UP mode action $\overline{d}Ab$: CP1, CP2 Individual input DOWN mode action Refer to the input action (counter)
Output mode	$\overline{n}E$ - $\overline{C}rr$ - \overline{P} - \overline{Q} - \overline{R}	Refer to the output action (counter)
Output time	$\overline{o}Ut2$: $\overline{0000}$ - $\overline{9999}$	$\overline{n}F$ (0 : Self holding output, 0.01 - 99.99 : Delay output time) \overline{C} - \overline{r} - \overline{P} - \overline{Q} - \overline{R} (0.01 - 99.99 : One shot output time)
Output time	$\overline{o}Ut1$: \overline{HoLd} - $\overline{9999}$	It is not displayed in the 1 st level output product
BATCH output	$\overline{b}AtE$: \overline{nonE} - \overline{rY} - \overline{Tr} - \overline{I}	Set the batch output port (\overline{rY} : Relay, \overline{Tr} : Transistor)
Computation speed	$\overline{C}PS$: $\overline{1}$ - $\overline{30}$ - $\overline{1k}$ - $\overline{10k}$	Set $\overline{1}$ or $\overline{30}$ when using contact
Pre-scale	\overline{PrES} : $\overline{000100}$ - $\overline{999999}$ $\overline{0001}$ - $\overline{9999}$	Default value $\overline{1000}$
Pre-scale decimal point setting	\overline{Pdot} : $\overline{000100}$ - $\overline{999999}$ $\overline{0001}$ - $\overline{9999}$	Able to set up to 5 decimal points and able to shift up to 4 digits
Display unit decimal point setting	\overline{dot} : $\overline{0000}$ - $\overline{0000}$ - $\overline{0000}$ - $\overline{0000}$	Applied when set decimal point on the display unit and able to set up to 3 decimal point
RESET TIME	\overline{rStE} : $\overline{0.1kS}$ - $\overline{1nS}$ - $\overline{20nS}$	Minimum signal range of external RESET signal input
Power backup memory	\overline{PaYr} : \overline{SRwE} - \overline{CLEr}	\overline{SRwE} : Save the computed value when power is OFF \overline{CLEr} : Initialize the computed value when power is OFF
Input logic check	\overline{SiG} : \overline{nPn} / \overline{PnP}	Varies depending on the handling of internal switch
Key lock	Key Lock \overline{LoCK} : \overline{LoFF} - \overline{Lon} - \overline{LSEt} - \overline{LrSt}	\overline{LoFF} : Key lock cancellation \overline{Lon} : all keys prohibited (⊖ excluded) \overline{LSEt} : Using \overline{MD} - \overline{UP} - \overline{DOWN} keys prohibited \overline{LrSt} : Using front part \overline{MD} prohibited

Pressing **RST** key will return to operation mode without saving. Return to operation mode if there is no key input more than 60 seconds. With function setup mode, it ignores external signal input and maintains output in OFF state

- * TOTAL product does not display setting lists such as output mode, OUT2 output time, OUT1 output time, BATCH output and etc
- * 1st setting product does not display OUT1 output time
- * Selecting \overline{NONE} for BATCH output setting, it limits the setting function and display function.

Counter output action mode

※ As for 1 Stage counter (OUT), it is the same as 2ND output (OUT2) action.

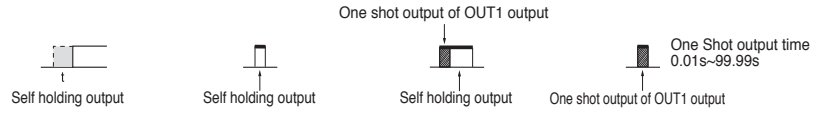

Output Mode	Input Mode			Post count up action
	UP	DOWN	UP/DOWN/A,B,C	
n				Coefficient value indication is maintained and setting up HOLD (0) leads to self holding output. Also, setting up time leads to OUT2 output after one shot delay setup. OUT1 and OUT2 become OFF when reset and return to Start.
F				Coefficient value indication is continuously processed and setting up HOLD (0) leads to self holding output. Also, setting up time leads to OUT2 output after one shot delay setup. OUT1 and OUT2 become OFF when reset and return to Start
L				Coefficient value indication is continuously processed during START state and OUT2 yields one shot output. Self holding output of OUT1 is turned off when OUT2 is turned OFF (Repetitive action)
r				Coefficient value indication is maintained during One Shot Time, and then resets. (Repetitive Action)
L				Coefficient value indication is continuously processed. OUT2 yields one shot output. Self-maintenance output of OUT1 is turned off after one shot time of out2
P				When coefficient value returns to initial state, then coefficient value indication is maintained for one shot time. After processing one shot time, it displays processed coefficient value. (Repetitive Action)
q				Coefficient value increases and OUT2 yields One Shot Output. The device is reset after the One Shot Output. (Repetitive Action)
R				Coefficient value is maintained and OUT2 yields one shot output. OUT1 and OUT2 are independent from each other. If OUT1 is same as setup value of SET1, it leads to one shot output or self-maintenance output. (In case of Level 1 setup type, OUT1 and OUT2 are same each other) Reset refers to OUT1 and OUT2 become OFF and coefficient value being initialized.

Input connection method

Input Logic Selection

Operate the conversion switch after confirming NPN/PNP indication which is displayed on the right

※ For receiving Open Collector Input, Input Logic (PNP/NPN) Conversion Switch is embedded internally to Pull up / Pull down the resistance of 4.7 kΩ (NPN Setup during shipment)

Input type	PNP setting		NPN setting	
	Voltage Input	Input PNP O.C	NPN voltage Input	NPN O.C
H	5 - 30 V d.c	5 - 30 V d.c	0 - 2 V d.c	0 - 2 V d.c
L	0 - 2 V d.c	OPEN	5 - 30 V d.c	OPEN

Input connection

●NPN (non-voltage input) state

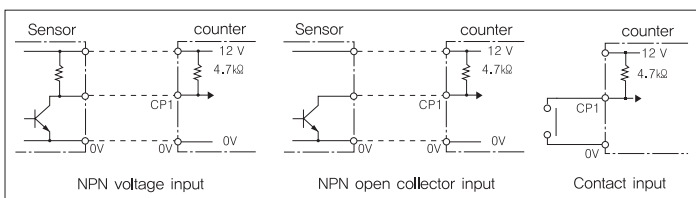

●PNP (voltage input) state

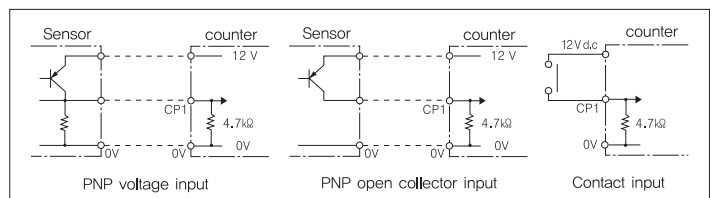

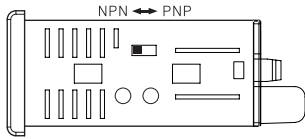

※ Input Logic Setup Status can be verified in Function Setup Mode.
 ※ Internal Impedance is 4.7kΩ, and switches over to Pull Up or Pull Down from NPN/PNP Selection.(Refer to Input Connection)

※ To prevent chattering during the use of Contact Input Counter, setup the coefficient speed at 1 or 30 cps in Function Setup Mode.

Counter input action

'A' needs value greater than min signal width, B need value greater than half of min signal width.

Input Mode	Up - A Inhibit input	Input Mode	Down - A Inhibit input
U-R		d-R	
U-b		d-b	
U-Rb		d-Rb	
Ud-R		Ud-d	
Ud-b		Ud-E	
Ud-C		Ud-F	

• When using encoder (incremental method). Please use Ud-C Ud-F (Noise) The input Logic of above list is PNP.

Counter output operation of exclusive indication (GE-T)

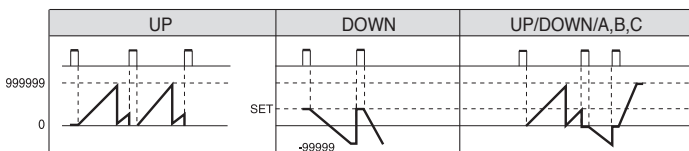

- Set value is first to decrease within Down Mode
- -99999 (6 digits), -999 (4 digits), it flashes and does not get counted
- Within UP MODE, it increases to the maximum display value, initializes to 0 and increases again

Timer mode setting method

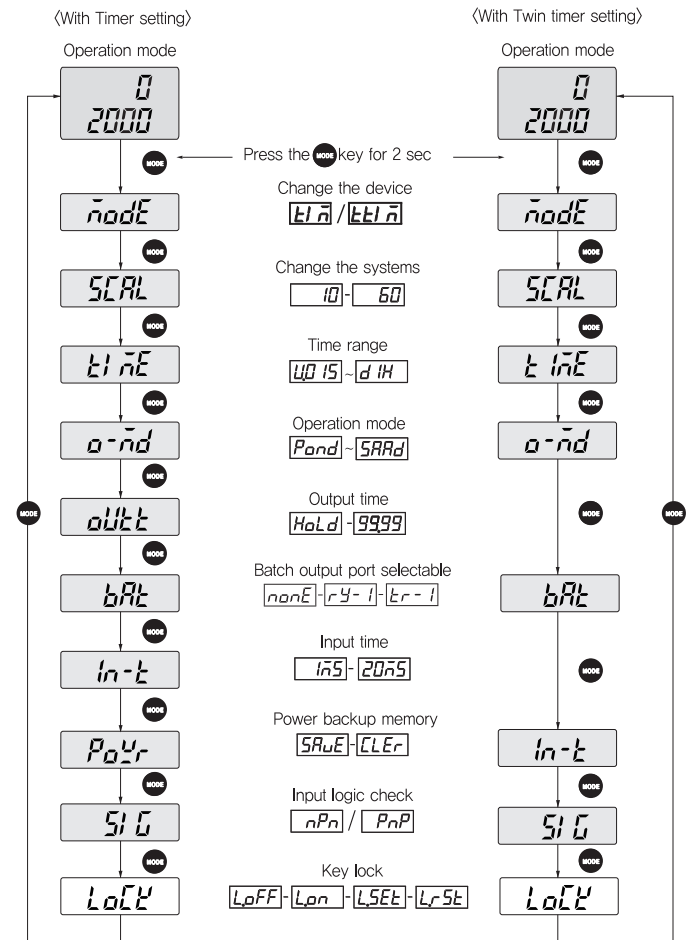

Function Setup Mode (Timer / Twin timer)

Setting lists	Setting information	Default value
Change the device $\bar{n}odE$	$E1\bar{n}$ - CnE : 1 st level setting type	$E1\bar{n}$: Timer
Change the system $SCARL$	$E1\bar{n}$ - $E1\bar{n}$ - $2CnE$: 2 nd level setting type	$E1\bar{n}$: Twin Timer
Time range $E1\bar{n}E$	$U0\bar{1}5$ - $U4\bar{1}5$ - $U15$ - $U1\bar{n}$ - $U1H$ - $d0\bar{1}5$ - $d15$ - $d15$ - $d1\bar{n}$ - $d1H$	0.01 s ~ 999999 h UP / DOWN selectable
Operation mode $a\bar{n}d$	TIM (TIMER setting) $Pond$ - $Sond$ - $Sond$ - $Sofd$ - $SinE$ - $SinE$ - $SFLV$ - $SRRd$ TTIM (TWN TIMER setting) $Pond$ - $Pofd$ - $Spond$ - $Sofd$ $PrUn$ - $SrUn$ Total(display only)	1 st level output model does not support $E1\bar{n}$ please refer to the output action mode chart for detailed information
Output time $oUtE$	$HoLd$ - 9999 s	Not display in the product (display only) and some of operation mode in the TWIN TIMER
BATCH output $bARt$	$nonE$ - $rY-1$ - $Er-1$	Set Batch output port (rY: Relay Er: Transistor)
Input time $in-t$	$1\bar{n}5$ - $20\bar{n}5$	Input terminal minimum input time selectable 1 ms / 20 ms (INHIBIT, START, RESET)
Power backup memory $PaYr$	$SrUe$ - $CLer$	$SrUe$: Save current time and batch counter value when OFF the power $CLer$: Initialize the computed value when OFF the power
Input logic check SiG	nPN : Non-voltage PnP : Voltage input	Varies depending on the handling of internal switch Changing the setting in the menu is prohibited, Only reading
Key lock $LoCK$	key lock setting in the operation state (4 levels) $LoFF$ - Lpn - $LSEt$ - $LrSt$	$LoFF$: Key lock cancellation Lpn : all keys prohibited (E excluded) $LSEt$: Using \odot , \ominus , $\omin�$ keys prohibited $LrSt$: Using font part SET prohibited

※ Total (product) does not have output time list and BAT setting list
 ※ 1st level output model does not support twin timer function

Timer time range

Range selection symbol		4 digits time range		6 digits time range	
UP	DOWN	Decimal System	Sixagecimal system	Decimal System	Sixagecimal system
$\overline{U} \overline{D} \overline{15}$	$\overline{d} \overline{0} \overline{15}$	99.99 s	59.99 s	9999.99 s	59 m 59.99 s
$\overline{U} \overline{15}$	$\overline{d} \overline{15}$	999.9 s	9 m 59.9 s	99999.9 s	9 h 59 m 59.9 s
$\overline{U} \overline{15}$	$\overline{d} \overline{15}$	9999 s	59 m 59 s	999999 s	99 h 59 m 59 s
$\overline{U} \overline{1h}$	$\overline{d} \overline{1h}$	9999 m	99 h 59 m	999999 m	9999 h 59 m
$\overline{U} \overline{1H}$	$\overline{d} \overline{1H}$	9999 h	99 d 23 h	999999 h	9999 d 23 h

* s : second m : minute h : hour d : day

Output connection

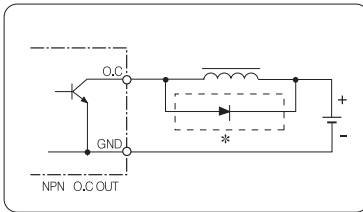

● Example of non-contact output

• When using the inductive load (relay and etc), please connect the surge absorber (diode and varistor) on the both ends of the load. Also please use with GND since the internal circuit and non-contact output are isolated from one another. please select the proper power for load and load. Non-contact output cannot exceed the max 30 V 100 mA.

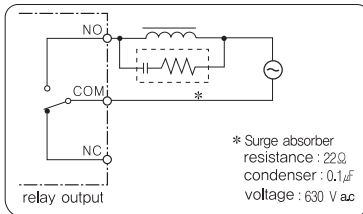

● Example of contact output

• Avoid the flow of excessive current since it is 250 V a.c NO 3 A (loadresistance) NC 2 A (load resistance), and the connection must correspond to standard connection method.

* Surge absorber
resistance : 22Ω
condenser : 0.1μf
voltage : 630 V ac

Timer operation mode

TIM(TIMER) Setting	TTIM(TWIN TIMER) Setting	For total model
\overline{Pond} Power RUN / ON delay	\overline{Pond} Power RUN -ON delay	\overline{PrUn} Power RUN
\overline{Sond} Signal START / ON delay	\overline{PaFd} Power RUN -OFF delay	\overline{SrUn} Signal RUN
\overline{SanI} Signal START / ON delay	\overline{Sond} Signal START -ON delay	
\overline{Sond} Signal RUN / ON delay	\overline{Sond} Signal START -OFF delay	
\overline{SoFd} Signal RUN / OFF delay	\overline{SoFd} Signal START -ON delay	
\overline{SInE} Interval / Signal RUN	\overline{SoFd} Signal START -OFF delay	
\overline{SInE} Interval / Signal START	\overline{PaFE} Power ON RUN -OFF time	
\overline{SFLU} Flicker / Signal START		
$\overline{SF-r}$ Flicker (Counter \overline{r} Mode)		
$\overline{SF-P}$ Flicker (Counter \overline{P} Mode)		
$\overline{SF-Q}$ Flicker (Counter \overline{Q} Mode)		
\overline{SRdd} Signal Addition		

• CP1/INHIBIT function stops the time.

• [S---] is activated when CP2 (START) is 'ON'

• [S---] is activated when CP2 is maintained 'ON', and resets when 'OFF'.

• [P---] activates with 'POWER ON'

* Setup \overline{LEr} as \overline{SRuE} in order to compensate for interruption of electric power during 'POWER OFF' (Indicates the Memorized Value when electric power is inputted again.)

Timer output action mode

* 1 Stage Setup Type Output is OUT.

* INHIBIT (CP1) temporarily stops the time.

■ \overline{Pond} Power RUN / ON delay

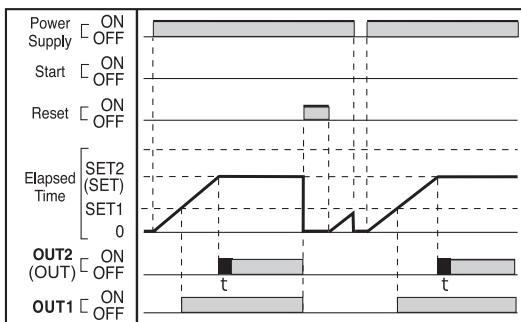

- Runs when 'POWER ON'
- When Reset signal is authorized, process value initializes and runs.

■ \overline{Sond} Signal START / ON delay

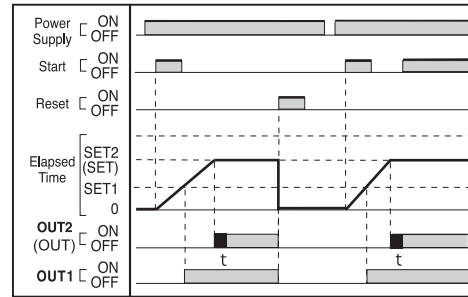

- Runs when START (CP2) is ON within the initial setup value
- When setup time is exceeded, it yields on shot output only when maintaining the indication value and setting up the (\overline{outE}).

■ \overline{SanI} Signal START / On delay (Counter F output mode action)

- Runs when START (CP2) is ON in the initial set value
- When setup time is exceeded, display value increases and yields output (Yields one shot output with \overline{outE} setting)

■ \overline{Sond} Signal RUN / ON delay

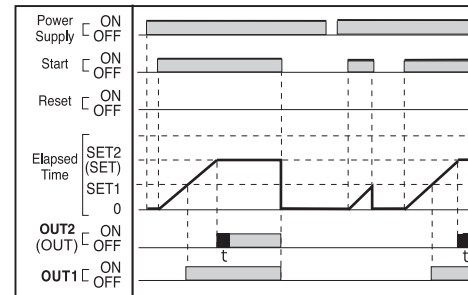

- Runs when CP2 (START) is ON and Resets when it is OFF within in the initial setup value.
- When setup time is exceeded, it maintains the displaying value and when sets the \overline{outE} , it yields the ON shot output.

■ \overline{SoFd} Signal RUN / OFF delay

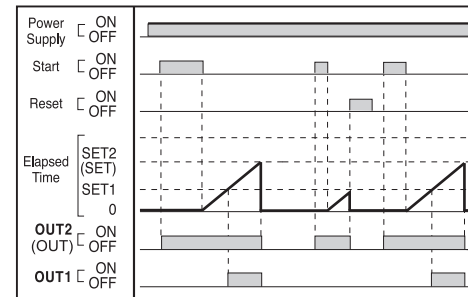

- Output will become ON only when START (CP2) is in ON state and time will display the initial value.
- Time activates the initial value to operate only when START (CP2) is in OFF state
- When setup time is elapsed, indication value will be initialized and output will become OFF.

■ \overline{SInE} Interval / Signal RUN

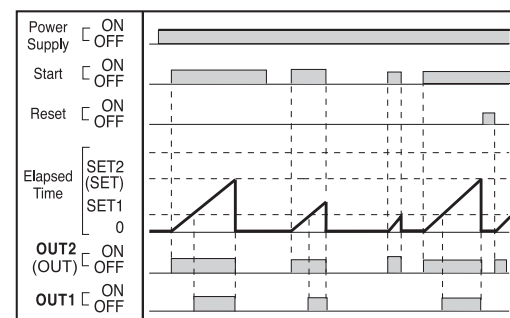

- Runs when START (CP2) is ON and Resets when it is OFF.
- Output is in ON state during the set time and initial value will be initialized and output will become OFF when set time elapses.

■ **5I nE** Interval / Signal START

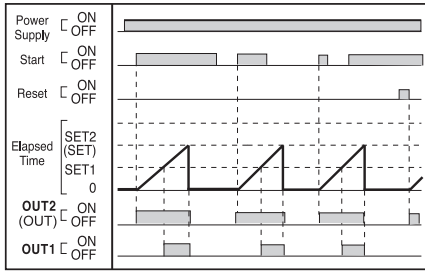

- Runs when START (CP2) becomes ON
- Output is in ON state during the set time and initial value will be initialized and output will become OFF when set time elapses

■ **5FLF** Flicker / Signal START

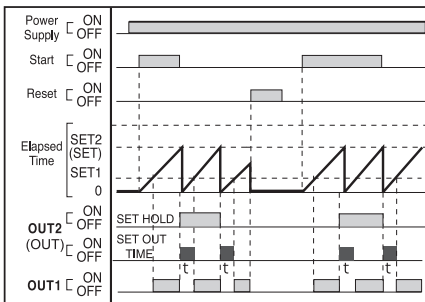

[HOLD] Setup (when output time is set at HOLD)

- Setup Set Time in Run Mode
- Maintains the indication of initial value when Power is "ON"
- Runs when becomes START (CP2).
- ON/OFF Repetitious Action of control output after reaching the Set Time.
- Initializes and stops when Reset is "ON"

ONE SHOT TIME Setup (when output time is set at more than 1)

- Setup Set2 Time in Run Mode.
- Maintains the indication of initial value when Power is "ON"
- Runs when Power is "ON"
- One Shot Output after reaching the Set Time.
- Initializes and stops when Reset is "ON"

■ **5F-r** Flicker (Counter **r** Mode)

■ **5F-P** Flicker (Counter **P** Mode)

■ **5F-Q** Flicker (Counter **Q** Mode)

■ **5Add** Signal Addition

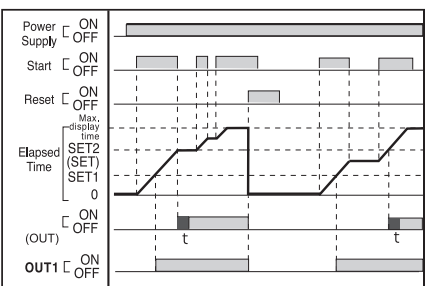

- Runs when maintaining START (CP2) as ON state and Holds when maintaining START (CP2) as OFF state (cumulative timer function)
- * does not operate within the DOWN time range

Twin timer output action

■ **PaOnd** Power RUN – ON delay

- RUNS when POWER is ON
- OFF Output for T1 Time / ON for T2 Time. Repetition
- Initializes and stops when RESET is ON

■ **PaFd** Power RUN – OFF delay

- RUNS when POWER is ON
- ON Output for T1 Time / OFF for T2 Time. Repetition
- Initializes and stops when RESET is ON

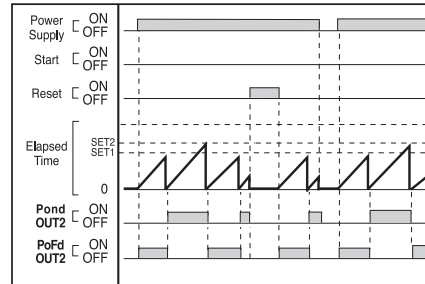

■ **SoOnd** Signal START – ON delay

- RUNS when POWER is ON
- Runs when START (CP2) is ON in the initial set value
- OFF Output for T1 Time / ON for T2 Time. Repetition
- Initializes and stops when RESET is ON

■ **SoFd** Signal START – OFF delay

- RUNS when POWER is ON
- Runs when START (CP2) is ON in the initial set value
- ON Output for T1 Time / OFF for T2 Time. Repetition
- Initializes and stops when RESET is ON

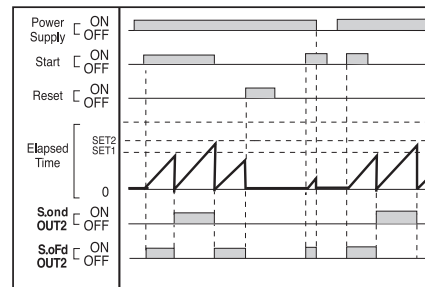

■ **PaOfE** Power RUN / OFF time

- Set the individual output control and fuse time
- Possible to set max 99.99sec when fuse time is set as $ouEt$.
- Runs when Power is ON
- ① Yields the output OUT1 during SET1 TIME AND OUT1 OFF during fuse time
- ② Yields the output OUT2 during SET2 TIME and OUT2 OFF during fuse time
- Repeats the operation ① and ②

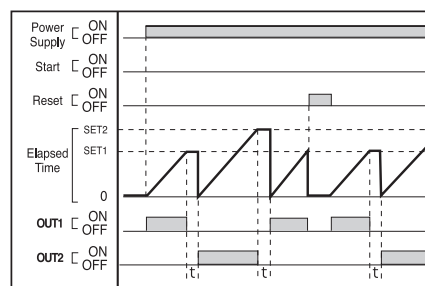

- t : possible to set from 0 to 99.99 sec by setting fuse time with $ouEt$

Timer action of exclusive indication(GE-T)

• OFF set is available for the up time range of decimal system (press  key for 2 sec)

PrUn Power RUN

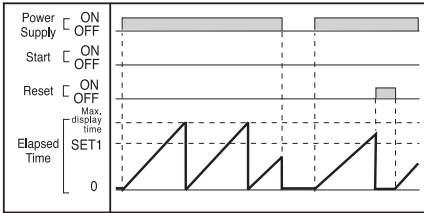

• In case of when Power is ON, supplying in the RUN RESET signal will initialize the indicating value and setting up the RUN Down mode will start to decrease the value from the set value.

SrUn Signal RUN

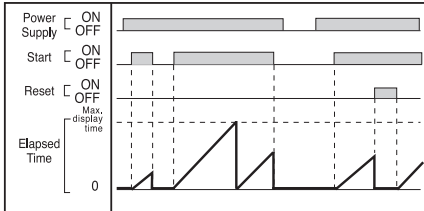

• Runs when turning ON the START (CP2) and Resets when turning OFF the START (CP2). Starts to decrease from the set time when Down Mode is being setup.

Batch counter

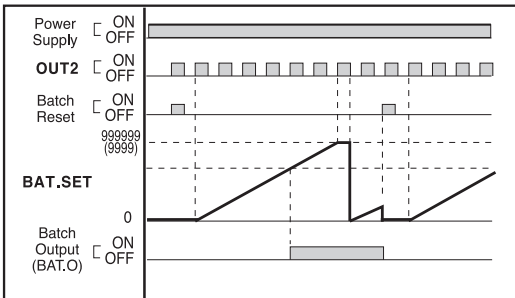







Batch computation and output operation

- Batch counting value continues to increase until Batch Reset is supplied in.
- When batch coefficient value exceeds 999999 (4 rows 9999), it initializes to 0 and display.
- In case of batch display state (BAT lamp is lighted), press the  key (located on the front side) to reset the batch value.
- Even in the batch display state, counter/timer action still operates normally.
- Batch coefficient increases when yielding the output as OUT2 (OUT)
- Batch output yields the output as (BAT.O). (BAT.O lamp is lighted)

Instant output setup

- Function switches over to instant output when the batch value is set at 0. (BAT.O lamp is lighted)

Batch Counter setup Method

1. Press  key
Enter to setup state, 6 rows (4rows) FND flickers, set "100" by pressing  /  key (When use want to set 100 batch.)
 2. Pressing  key will complete setup. (Pressing  key will exit without changing)
 3. Pressing  key will return to operation mode. (Left side BAT lamp off)
- * Properly operates within BATCH display mode
* Possible to setup BAT only with *Er-1, rY-1* BAT setting.

Batch Switchover of 2 Stage Setup Type

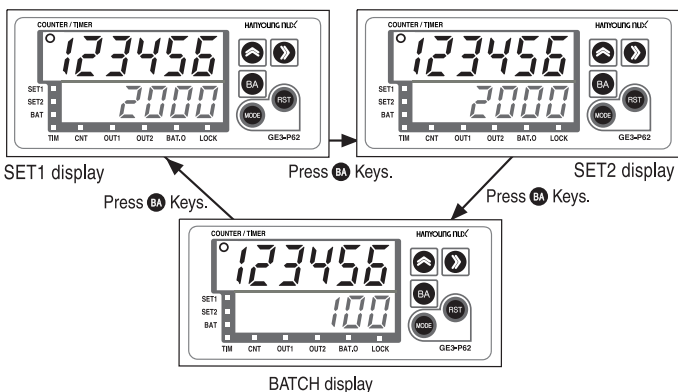

Dimension and panel cutout

[Unit:mm]

GE7

Dimension

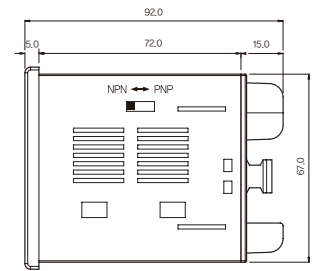
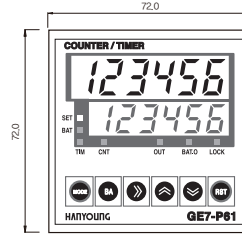

Panel cutout

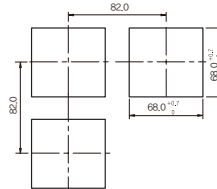

GE4

Dimension

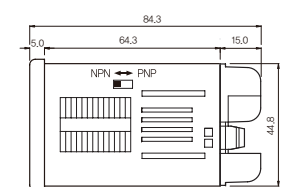
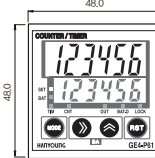

Panel cutout

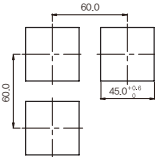

GE6

Dimension

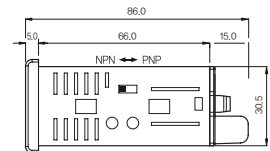

Panel cutout

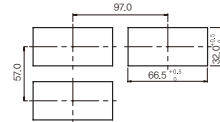

GE3

Dimension

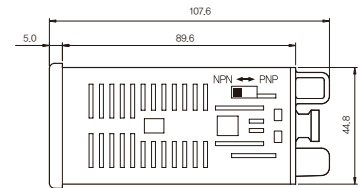

Panel cutout

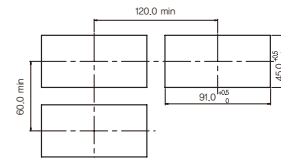

Connection diagram

■ GE4-P□1

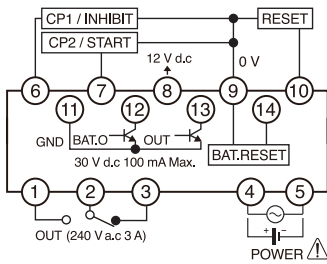

- * Connection of NPN input
- * GE4-T6: Total model does not have relay output with transistor.

■ GE4-P□2

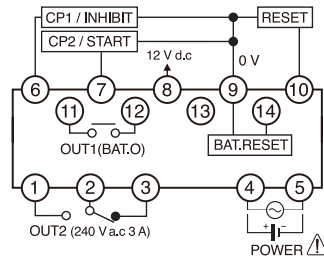

■ GE6-P□1

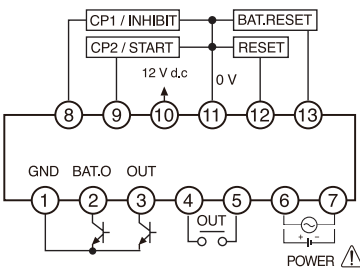

- * Connection of NPN input
- * GE6-T6: Total model does not have relay output with transistor.

■ GE6-P□2

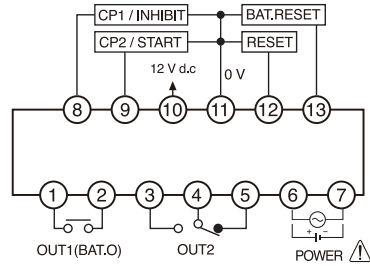

■ GE3-P□1

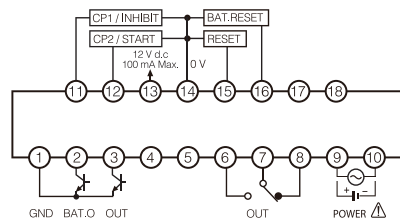

- * Connection of NPN input
- * GE3-T6: Total model does not have relay output with transistor.

■ GE3-P□2

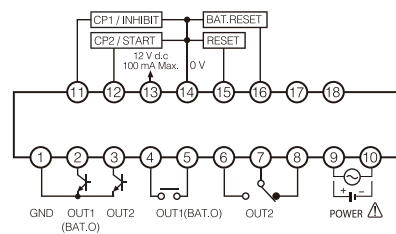

■ GE7-P□1

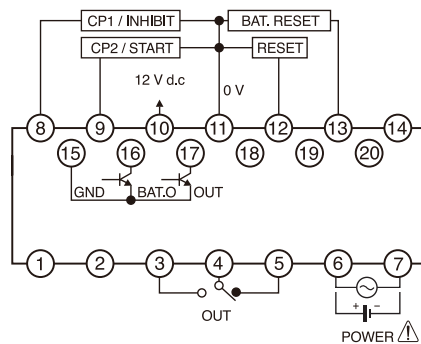

- * Connection of NPN input
- * GE7-T6: Total model does not have relay output with transistor.

■ GE7-P□2

