

CONTROL TECHNIQUES



COMMANDER C

FLEXIBILITY FOR COUNTLESS APPLICATIONS

AC DRIVES, GENERAL PURPOSE

DRIVE OBSESSED

THE 6TH GENERATION OF EXCELLENCE IN MOTOR CONTROL

COMMANDER C

0.25 kW to 132 kW (0.33 hp to 200 hp)

Linear V to F, Square V to F, Dynamic V to F,
Set Point V to F, Stator Resistance Compensation,
RFC-A (enhanced open-loop performance)

Commander C combines efficiency and reliability to offer optimum performance for a wide range of applications.

With 9 frame sizes, it covers powers from 0.25 to 132 kW / 0.33 to 200 hp. Essential features are built in, including PLC capabilities for simple programming needs, dual STO safety function (C300 variants only), braking transistor and PID control.



Free 5 year warranty*

Our Commander C series is built to cope with harsh environments. In fact, it is so reliable we are confident enough to supply it with a free five-year warranty.

Now you can buy with the same confidence.



THE ULTIMATE ALL-IN-ONE DRIVE

KEY BENEFITS

Adaptable to your application

Whether you have a single application or a variety of different ones, Commander C fits right in. With all essential features built-in, it's ready to go right out of the box.

Integrated functional safety

The Dual Safe Torque Off (STO) feature, certified to the highest level of machine safety, SIL3/PLe, and compliant to EN/IEC 61800-5-2, prevents the motor from moving unexpectedly, protecting both equipment and operators.

On-board PLC

The generous 30kB user space allows for add-on programmable functions, more elaborate I/O features and special software that enables greater machine control. The on-board PLC also eliminates the need for an external controller, saving both on cost and space.

Compact design

Commander C is one of the most compact drives within its category, taking little space in the cabinet and minimizing installation cost.

Super quick start-up

To get started you only need to set-up 4 parameters (motor rated current, RPM, voltage and power) and for your convenience we've listed them on the front cover of the drive.

Flexible connectivity

The plug in communication modules enable integration with the most common industrial fieldbuses.

Worldwide availability and outstanding service

Need expert advice and support? Wherever you are in the world we've got you covered via our sales offices or Control Techniques approved distributors.

CASE STUDY: GIVING BACK TO NATURE AT SINGAPORE BOTANICAL GARDENS

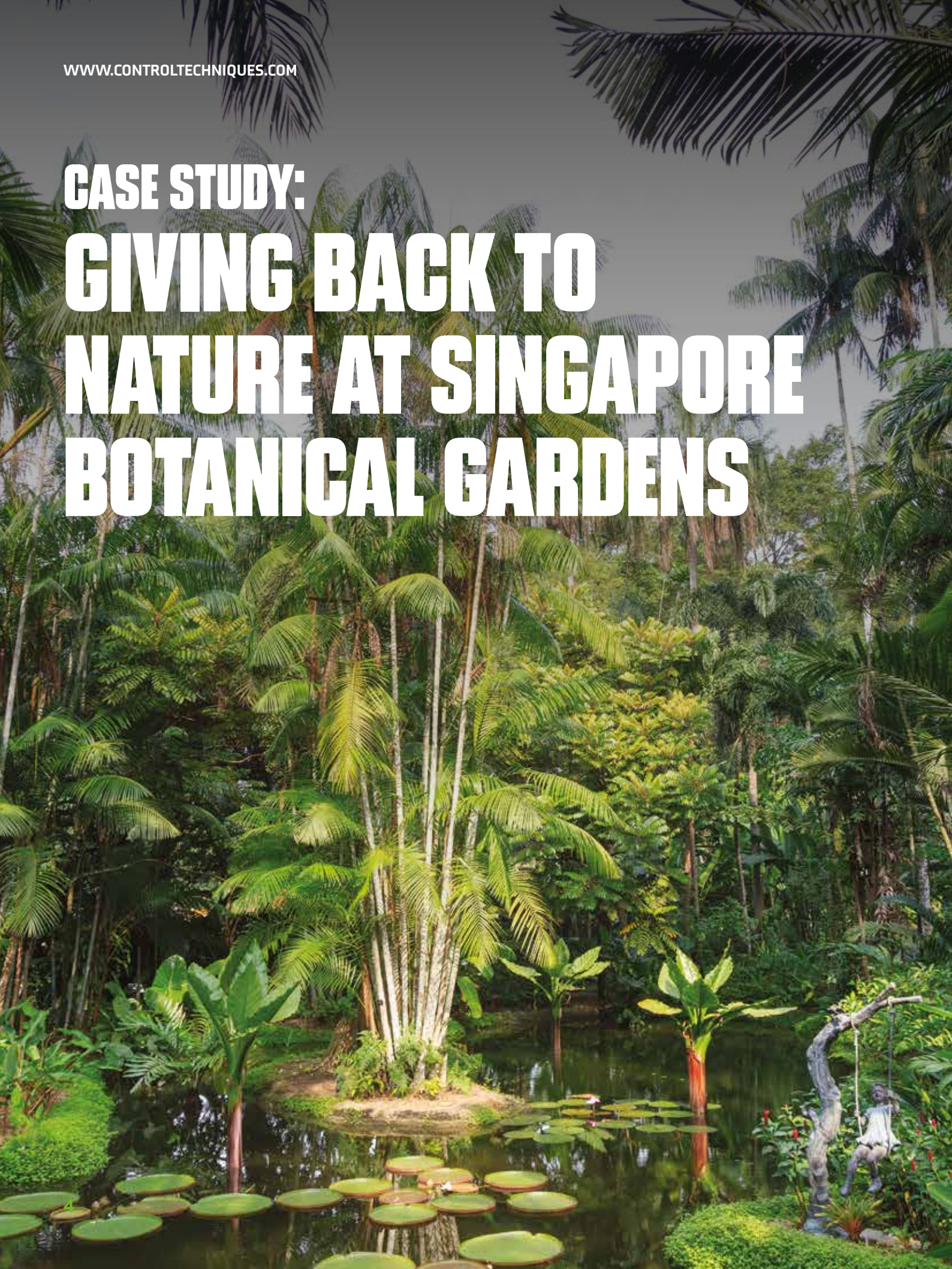

COMMANDER C DRIVES SAVE ENERGY

Established in 2012, Success Electric Pte Ltd specialises in manufacturing low-voltage switchgear and control gear assemblies for diverse market sectors in Singapore and numerous global projects. The company's electrical power distribution solutions range from main switch boards (MSB) to distribution boards (DB). It also provides motor control and automation panels for air conditioning & mechanical ventilation (ACMV) systems, plumbing & sanitary, fire pump, refuse chute, and machinery control systems.

The Challenge

Singapore Botanic Gardens is the first and only tropical botanic garden on the UNESCO World Heritage List. Its new Gallop Extension is eight hectares of framed landscapes composed of native plants and forests, contributing to the gardens' rich heritage and its role in research, conservation, education, and recreation. As a natural extension of the gardens' nature area, it covers the rain forest and the learning forest, educating visitors on forest ecology and conservation significance.

With a new addition to the visitor attraction, the Botanical Gardens required an irrigation booster pump system to supply water to the entire Gallop Extension field of plants and forests. On winning the contract, Success Electric set about the mission to find the right drive for the job.

The Solution

Control Techniques' Commander C drives are integrated into Success Electric's irrigation booster pump system controller. Commander C controls and regulates the pumps to distribute the water supply to the entire field of native plants and forests at programmed times of the day and night, keeping the plants watered while saving energy and natural resources. Commander C provides a low starting current while ramping up to full speed at 50Hz, thus reducing the overall energy consumption. The easy-to-use LED keypad and a parameter guide on the front of the drive allow the gardens' maintenance team to modify the pressure settings for the pump sets.

The Benefit

"The solution has reinforced the energy saving benefits that variable speed drives deliver. In this case, Singapore Botanical Gardens is making energy savings of 30%. With the compact and programmable Commander C drives, we were able to reduce the panel footprint, leaving more space for nature that visitors can enjoy."

Anthony Yeo
Success Electric
Business Manager



CASE STUDY: SIMPLIFYING SYSTEM DESIGN AT SCHULTHESS



COMMANDER C DRIVES WITH BUILT-IN LAUNDRY FEATURES

Schulthess is the leading Swiss supplier of washing equipment. Ever since its inception in 1845, durability and performance have been at the core of the solutions designed and built by the company. The Schulthess laundry equipment is easy to operate, economical to use and boasts excellent process reliability. Each machine has been tested for 30,000 cycles – equivalent to a lifetime of 20 years.

The company is constantly investing in research and development, which has helped to secure only the highest grade materials and processes for durable and environmentally-friendly products.

The Challenge

As they've embarked on a new product development, the Schulthess team has been on the lookout for an inverter drive supplier that can meet their demands for quality and performance, while also offering a technological advantage and satisfying the regulatory requirements. Inverter drives are crucial components in the design of the laundry solution as proprietary inverter drive technology provides smooth, reliable power for better wash and extraction, reduces energy and water consumption and improves the customer experience.

The Solution

The Swiss and UK team at Control Techniques have worked closely with Schulthess' R&D department to provide the best match to their needs. Commander C, with the built-in laundry specific software, proved to be the right solution. Commander C can detect imbalances caused by laundry becoming tangled into large lumps and initiate a tumbling sequence to untangle the load. Thanks to this feature the wash cycle is much smoother and the machine life is extended as there's less stress to the mechanical parts.

The on-board PLC has allowed the joint teams to further expand the laundry specific capabilities while also reducing the size of the installation as an external controller was no longer required.

Commander C is built to cope with harsh environments and we are confident in its durability to supply it with a free 5 year warranty. This has been a valued benefit to guarantee the quality of the Schulthess machinery.

The Benefit

“Since switching to Commander C, we have been able to simplify the system design. For example, we no longer need an imbalance sensor. Imbalance detection and broken belt detection are all built-in the PLC. Commander C's motor control performance is outstanding, and it has greatly improved our testability and troubleshooting compared to the previous drive.

Throughout this project, we have had excellent support from the Control Technique teams in the UK and Switzerland and it's been a great working partnership. We will most certainly use Control Techniques' inverters for our future projects.”

Mr. Remo Bucher
Engineering Manager



COMMANDER C DRIVES AT THE HEART OF GENERAL PURPOSE APPLICATIONS WORLDWIDE



Conveyors

- Reliable speed control with fieldbus communications
- S-ramp acceleration / deceleration profiling provides smooth speed transitions minimizing machine jerk
- Overload capacity up to 180% for rapid acceleration or load changes
- Built-in STO function ensures operator safety by preventing the motor from moving unexpectedly



Access Control

- Smooth motion with enhanced open loop control
- Compact physical size allows the drive to be mounted easily in small control cabinets
- Highly reliable in harsh environments, providing long lasting service



Lifts, Hoists, Winches

- Adjustable mechanical brake sequencing with torque proving function – no need for an external controller
- Embedded PLC functionality can manage local I/O reducing the need for an external controller





Process

(Mixers, Crushers, Agitators, Centrifuges, Extruders)

- Ease of integration to external PLC or other management systems through powerful networking options
- Conformal coating for enhanced environmental protection
- Overload capacity up to 180%
- Highly stable motor control



Pumps, Fans, Compressors

- Improved energy efficiency during periods of low demand
- On board PLC & PID functionalities make advanced control easy and efficient without the need of an external controller
- Skip Frequencies allow users to easily avoid equipment resonant frequencies, reducing high vibration levels
- Supply Loss Ride Through will keep the drive up and running through most power outages



COMMANDER C

KEY FEATURES

Easy motor pairing and performance control

V/Hz by default for easy set-up

- Slip compensation
- Multi-motor control
- 100% torque available to 1 Hz
- Square law V/F mode
- Dynamic V/F mode
- Auto tune (stationary and rotating)

Enhanced open loop Rotor Flux Control

- Closed current loop for greater stability
- Auto tuning (stationary and rotating)



Flexible connectivity

The SI Interface on Commander C enables integration with a wide range of industry standard fieldbuses to allow remote control and diagnostics across different networks. Additionally, the AI-485 Adaptor option permits connection to RS485 networks using Modbus RTU.



Robust and reliable design

- PCBs conformal coated for resilience to harsh environments
- Patented air flow system cools and protects components
- Supply voltage tolerance for smooth operation during disturbances to supply
- Intelligent three speed user replaceable fan with failure detection
- Trip avoidance features take action instead of tripping out:
 - i. Load shedding reduces speed at current limits
 - ii. Supply loss ride-through keeps motor running during brown outs
- High overload capability: 180% for 3 seconds (RFC-A mode) or 150% for 60 seconds (Open loop mode)
- IP20 ingress protection as standard and conduit box UL Type 1 available as an accessory

Embedded intelligence reduces costs

- Onboard PLC
- Built-in independent PID control

Energy saving

- Dynamic V/Hz - improves efficiency by reducing motor losses during low demand
- 98% efficient - only 2% of energy is lost during the conversion process
- Low power standby mode - drives can be idle for significant periods, saving energy
- Automatic 3-speed cooling fan - keeps energy usage & acoustics noise to a minimum by intelligently responding to load and the environment
- Square Law V/F mode - optimized for quadratic loads to reduce motor losses

Input / Output

Onboard as standard

- 3 x Analog I/O
- 5 x Digital I/O
- 1 x Relay
- 2 X STO (C300 only)

SI-I/O

- 4 x Digital I/O
- 1 x Digital input
- 3 x Analog inputs (default) / Digital inputs
- 2 x Relays



COMMANDER C INTUITIVE SOFTWARE

Intuitive commissioning software

For fast task based commissioning and easy maintenance, **Connect** offers a familiar **Windows™** interface and intuitive graphical tools to enhance data analysis.

The dynamic drive logic diagrams allow the visualisation and control of the drive in real time. The parameter browser enables viewing, editing and saving of parameters as well as importing parameter files from our legacy drives.

Advanced machine control

For more advanced applications, **Machine Control Studio** provides a flexible and intuitive environment for programming. This is possible thanks to the onboard PLC that increases the drives functionality at no extra cost.

Control Techniques also provides support for customers' own function block libraries, with on-line monitoring of program variables with user defined watch windows and help for on-line change of program, in line with current PLC practice.

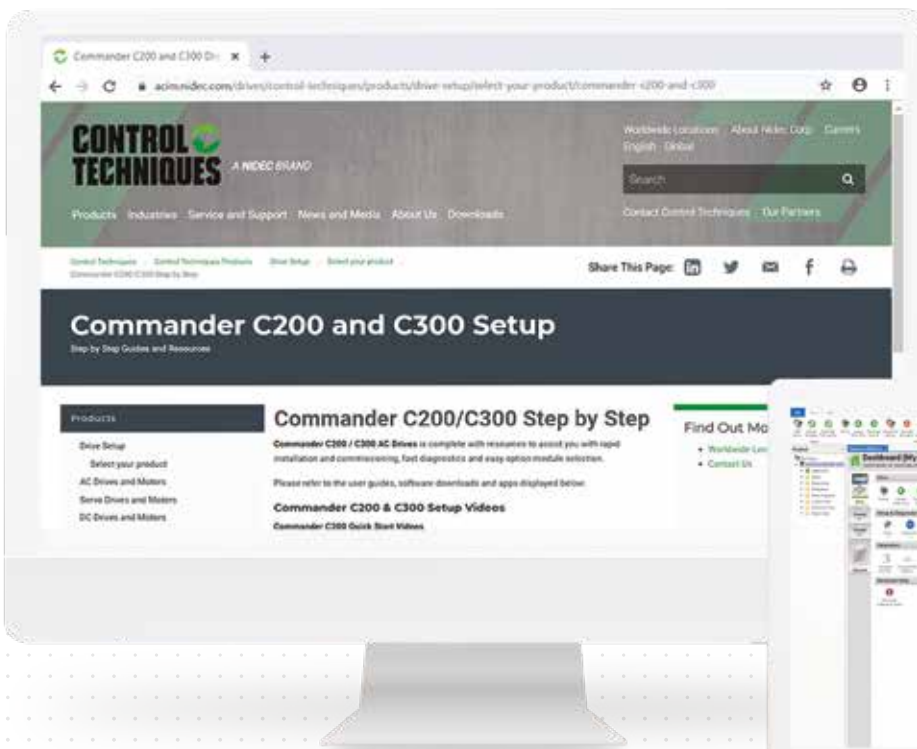

Connect Software

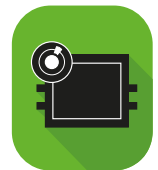

Machine Control Studio Software

Free to download:
www.controltechniques.com/commander-c-setup

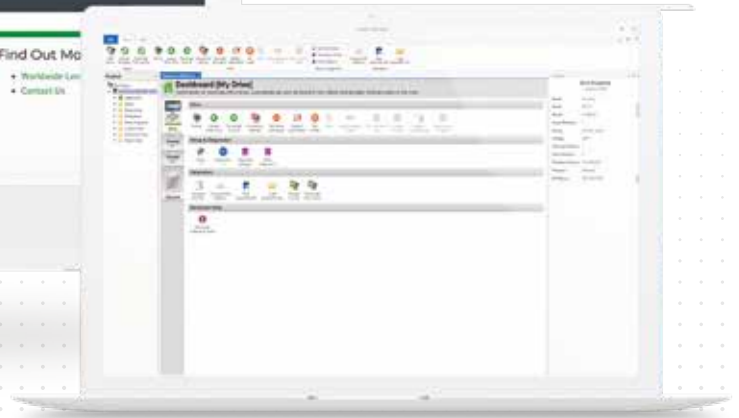

COMMANDER C VIRTUAL DEMO TOOL

The **Commander C Virtual Demo Tool** provides a safe and accessible first experience with Commander C variable speed drives and allows you to get familiar with its keypad and menu structure.

This digital replica of a Commander C drive, motor and control allows you to use the virtual keypad to set-up the drive parameters for commissioning just like in a real situation. Once the key parameters have been set, the drive can be enabled and the motor shaft will spin.

To see just how easy it is to set-up the drive, visit: www.controltechniques.com/virtual-demo-tool



Diagnostics? There's an app for that



Diagnostic Tool App

The Diagnostic Tool App is a fast and simple tool, which allows users to quickly solve any error codes that the drive may show.

Download from:
controltechniques.com/mobile-applications



Free online help: Drive-Setup.com

You'll have permanent free access to lots of web pages with useful information, like user manuals, 'how-to' videos and guides.

YouTube Training

Access a series of Commander C training videos, available on YouTube, visit:

www.youtube.com/controltechniques

COMMANDER C

SPECIFICATIONS

Power & Control	
Supply Requirements	100 V to 120 V ± 10 % 200 V to 240 V ± 10 % 380 V to 480 V ± 10 % 500 V to 575 V ± 10 % 500 V to 690 V ± 10 % Maximum supply imbalance: 2 % negative phase sequence (equivalent to 3 % voltage imbalance between phases)
Input Displacement Power Factor	0.97
Phase	1 and 3 (model dependent)
Power Range	0.25 to 132 kW / 0.33 to 200 hp
Input Frequency Range	45 to 66 Hz
Output Frequency/Speed Range	0 to 599 Hz
Switching Frequency	Size 1 - 4: 0.667, 1, 2, 3, 4, 6, 8 12 & 16 kHz Size 5 - 9: 2, 3, 4, 6, 8 12 & 16 kHz C300 PM: 2, 3, 4, 6, 8 & 12 kHz (Factory default = 3kHz)
Heavy Duty Overload Capability	150 % for 60 s (open-loop mode), 180 % for 3 s (RFC-A or PM mode)
Motor Control	C200, C300: Induction Motors C300 PM: Permanent Magnet Motors
Operating Modes	Linear V to F Square V to F Energy Optimiser (Dynamic V to F) Set Point V to F Stator Resistance Compensation RFC-A (enhanced open-loop performance) Sensorless Permanent Magnet Motor Control (C300 PM Only)
Stopping Modes	C200, C300: Coast, Ramp, Ramp & DC Injection Braking, DC Injection Braking with 0 Hz detect, Timed DC Injection Braking, No Ramp C300 PM: Coast, Ramp, No Ramp, Distance Stop Note: No Ramp will stop the motor as fast as possible under current-limit (external resistor required). Built-in braking transistor, external resistor required
Communication & Interfaces	
Communications	MODBUS RTU, EtherCAT, PROFIBUS, EtherNet IP, DeviceNET, CANopen, PROFINET, POWERLINK, BACnet IP, INTERBUS (all available with AI/SI-options)
Keypads	Fixed LED keypad Remote IP54 Keypad (available as an accessory) Remote RTC Keypad (available as an accessory) HMI (available as an accessory)
User Software Tools (Free To Download)	Connect (PC commissioning & cloning tool): <ul style="list-style-type: none"> • Project based commissioning tool • Clone and share parameter files • Compare to defaults • Trouble-shoot systems • Run scope traces • Parameter help & tips Machine Control Studio for on-board PLC programming <ul style="list-style-type: none"> • CODESYS based • Included programming languages: ladder diagram, structure text, function block diagram, instruction list, sequential function chart, continuous function chart • Function block libraries • Online monitoring of program variables with user defined watch windows • Support for online change of program
Programmable Inputs & Outputs	
Functional Safety STO	Dual STO SIL3 PLe
Analogue	2 x Analogue input Analogue input 1 possible settings: 0-10 V, 0-20 mA, 4-20 mA (Hold), 4-20 mA (Low), 4-20 mA (Stop), 4-20 mA (Error) Analog input 2 possible settings: 0-10 V, Digital 1 x Analogue Output 0-10 V

Digital	4 x Digital inputs (1 frequency or thermistor input) 1 x Digital input / output (can be used as a frequency or PWM output to represent analogue value)
Digital Input Logic	Positive
Relay	1 x Relay (single pole, single throw)
Accuracy	Frequency 0.02 %, Analogue input 1: 11 bit plus sign, Analogue input 2: 11 bit. Current typical 2 %.
Extra I/O with SI-I/O Option Module (Available as an Accessory)	3 x Analogue inputs (default) / Digital inputs 4 x Digital input / output 1 x Digital input 2 x Relays (single pole, single throw) Positive or Negative Logic (PNP or NPN)
Supported Encoders with SI-Encoder (Available as an Accessory)	Incremental AB (5 V, 8 V, or 15 V)

Mounting & Environment

IP Rating	IP20 Conduit Box UL Type 1 ingress protection (available as an accessory)
Storage Temperature	-40 °C to 60 °C (-40 °F to 140 °F)
Operating Temperature without De-Rate	-20 °C to 40 °C (-4 °F to 104 °F)
Operating Temperature with De-Rate	-20 °C to 60 °C (-4 °F to 140 °F) Frames 1 to 4 -20 °C to 55 °C (-4 °F to 131 °F) Frames 5 to 9
Cooling	Integral cooling fan
Altitude	≤3000 m (≤1000 m no de-rate; 1000 m to 3000 m derate 1 % every 100 m)
Humidity	95 % non-condensing at 40 °C / 104 °F - EN61800-2(3k3)
Pollution	Pollution degree 2 - dry, non-conducting pollution only
Vibration	Reference standard IEC60068-2-27, IEC60068-2-29 bump test, IEC60068-2-64 random vibration test, IEC60068-2-6, EN61800-5-1 sinusoidal vibration test. Tested to Environmental Category ENV3
Mechanical Shock	Tested in accordance with IEC 60068-2-27 and IEC 60068-2-29
Mounting Methods	Frame 1 to 4 – Surface mount via mounting holes or DIN Rail mount Frame 5 to 9 – Surface mount via mounting brackets or through-panel mount via through-panel mounting kit
Mounting Clearance	0 mm either side, 100 mm above and below
Overvoltage Category	Category III
Corrosive Environments	EN 60721-3-3 IS09223 Class C3
Maximum Motor Cable Length	75 m Frame 1 100 m Frames 2 to 4 200 m Frames 5 to 6 250 m Frames 7 to 9

Standards

Approvals	CE (European Union), cUL Listed (USA and Canada), DNV (marine applications), KC (Korea), RCM (Australia/ New Zealand), EAC (Russian Customs Union), UKCA (United Kingdom), C-Tick (Australia)
-----------	---

Product Safety Standards	UL 508C IEC/EN/KN 61800-5-1 CSA C22.2 No.274 GB12668.501-2013
--------------------------	--

TÜV	C300 models only: The Safe Torque Off (STO) function may be used as a safety component of a machine. Type examination certificates by TÜV Rheinland: Frame sizes 1 - 4: No. 01/205/5383.03/18 Frame sizes 5 - 9: No. 01/205/5387.02/18 Functional safety parameters: EN ISO 13849-1 - Cat 4, PL _e EN61800-5-2/EN62061/IEC 61508 - SIL3 UL functional safety approval: FSPC E71230
-----	---

Product EMC Standards	IEC/ EN 61800-3 Immunity and Emissions (Meets equipment category C3 with internal filter, with an external EMC filter C1 or C2 can be achieved) EN 61000-6-2: Immunity for industrial environments (Complies) EN 61000-6-4: Emissions for industrial environments (External EMC filter required to comply) EN 61000-3-2: Harmonic current emissions (External line reactor required to comply)
-----------------------	---

RoHS	Complies with the Restriction of Hazardous Substances Directive (2011/65/EU)
Immunity Compliance	Second environment (Industrial)
ISO	Manufacturing facilities comply with ISO 9001:2015 and ISO 14001

Warranty

Warranty	5 Years (warranty terms and conditions apply)
----------	---

Accessories

Remote Interfaces	Remote keypad IP66, Remote keypad RTC, HMI
Filters & Cables	External EMC filters, line reactors
PC Tools Programming Cable	CT communications cable
Communication & Feedback, SI-Options	AI-485 24 V Adaptor (MODBUS), SI-EtherCAT, SI-PROFIBUS, SI-Ethernet, SI-DeviceNET, SI-CANopen, SI-PROFINET, SI-POWERLINK, SI-Encoder, SI-I/O, SI-BACnet IP, SI-Interbus (500 kBd or 2 MBd)
Back-up & Cloning	AI-Back-up Adaptor & AI-Smart Adaptor (Includes 4GB SD card)
Conduit Box	For UL Type 1 ingress protection

Protection	
Conformal Coating	✓
Fire Mode	✓
DC Bus Undervoltage Error Level	100 V models: 175 Vdc 200 V models: 175 Vdc 400 V models: 330 Vdc 575 V models: 435 Vdc 690 V models: 435 Vdc
DC Bus Overvoltage Error Level	Frame sizes 1 - 4: 100 V models: 510 Vdc 200 V models: 510 Vdc 400V models: 870 Vdc Frame size 5 - 9: 200V models: 415 Vdc 400 V models: 830 Vdc 575 V models: 990 Vdc 690 V models: 1190 Vdc
Drive Overload Error	Programmable: Default settings: 180% for 3s, 150% for 60s
Instantaneous Overcurrent Error/Limit	220% of rated motor current
Phase Loss Error	DC Bus Ripple Threshold Exceeded
Overtemperature Error	Control Board Over Temperature, Inverter Model Temperature, Inverter Thermistor Temperature, Drive heatsink temperature exceeds 95°C (203°F)
Short Circuit Error	Protection against output phase-to-phase fault
Ground Fault Error	Protection against output phase-to-ground fault
Motor Thermal Protection	Electronically protects the motor from over-heating due to loading conditions
Keep Running	Parameter set to avoid errors and machine downtime
Dedicated Thermistor Input	Avoid downtime or machine damage due to overheated motor
General	
Items supplied with the drive	Step-By-Step Guide, Safety Information, Grounding bracket, Surface mounting brackets (frame 5 to 9)

COMMANDER C

FUNCTIONALITY

Modbus RTU Communications (available with AI-485 Adaptor)	
Control Word Control	✓
Serial Baud Rate	600 to 115200 bps
Modbus RTU Mode	8.2NP, 8.1NP, 8.1EP, 8.1OP, 7.1 EP, 7.1 OP
On Board PLC	
User Memory Space	30 KB
Pre-set Programs (Available on Request)	Unbalanced Load Detection (Laundry drive variant), Solar Pump (Available in Connect)
Custom Application Parameters	64
Reference	
Selectable References	Analogue input 1, analogue input 2, pre-set speeds, keypad reference, motorised pot reference, frequency input, PID output or communication control
Jog Reference	✓
Up / Down % Reference (Motorised Pot)	✓
Bi-Polar Reference	✓
Pre-set Speeds	8
Pre-set Timer	✓
Skip Frequencies	3
Skip Frequencies Dead Band	✓
Local/Remote	✓
S-Ramp	✓
Acceleration Rates	8
Deceleration Rates	8
Frequency Input Reference (Pulse Train)	0 Hz to 100 kHz
Torque Reference	✓

Application Specific	
PID Controller	PID Control
PID Feedforward	✓
PID Threshold Detector	✓
PID Slew Rate	✓
Input Scaling	✓
Run Permit (Latching Run)	✓
Control	
Motor Stability Optimiser	✓
Slip Compensation	✓
Auto-tune	replace tick with: "Static, Rotating & Inertia"
Catch an Already Spinning Motor	✓
Speed Feedback via SI-Encoder Option	✓
Second Motor Set-up	✓
Motor Pre-Heat Control	✓
Built-in Braking Transistor (External Resistor Required)	✓
Mechanical Brake Controller	✓
Supply Loss Detection	✓
Motor Phase Loss Detection	✓
Low D.C. Link Operation	✓
Analogue Input Control	✓
Analogue Output Control	✓
Digital Input Control	✓
Digital Output Control	✓
Relay Control	✓
Logic Function Control	✓
Timer Function Control	✓
Limit Switch Control	✓
Temperature Monitoring	✓
Keypad Button Assignment	✓
Programmable Output Current Limit	✓
General	
Error History Log	10
Auto-Reset After Error	✓
Error Time Stamping	✓
Power Loss Ride Through	✓
Run Time Log	✓
Cloning	Via: SD Card, Connect
Energy Meter	✓
Security PIN	✓

COMMANDER C

TERMINAL DIAGRAM

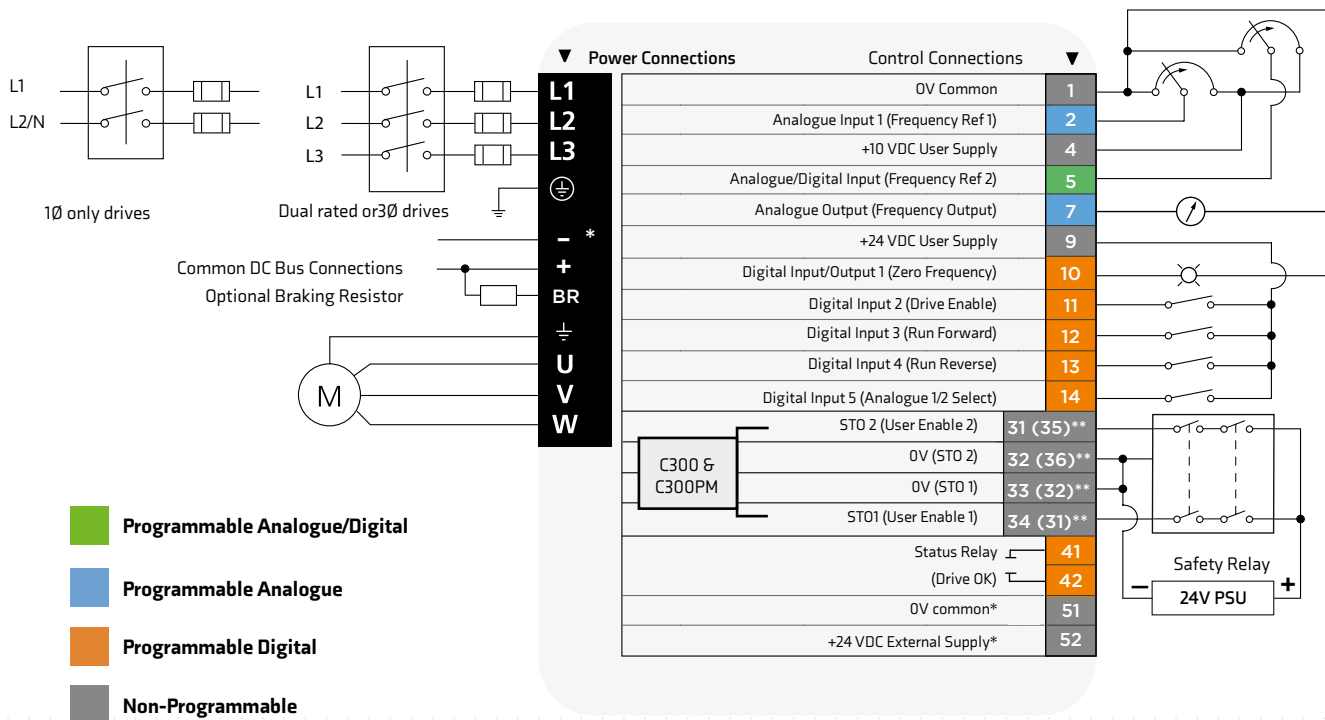

* Only frame size 6 to 9

Pin#	Default Function	Type/Description	Notes
1	0V Common	Common for external analog signals	
2	Frequency reference 1	Single ended analog input 11 bit	0 to +10 Vdc, 0-20 mA or 4-20 mA or 20-4 mA or 20-0 mA
4	+10 Vdc user supply	Reference supply	5 mA Output current
5	Frequency reference 2	Single ended analog input 11 bit or digital input	0 to +10 Vdc or 0 to +24 Vdc
7	Output frequency	Single ended analog output	0 to +10 Vdc
9	+24 Vdc user supply	Digital I/O supply	100 mA
10	At zero frequency	Digital I/O 1	0 to +24 Vdc
11	Enable*	Digital input 2	0 to +24 Vdc
12	Run forward	Digital input 3	0 to +24 Vdc
13	Run reverse	Digital input 4	0 to +24 Vdc
14	Analog input 1/2 select	Digital input 5	0 to +24 Vdc
31(35)**	Safe Torque Off/Drive enable	STO 2	0 to +24 Vdc
32(36)**	0V STO 2	0V STO 2	0V common for STO 2
33(32)**	0V STO 1	0V STO 1	0V common for STO 1
34(31)**	Safe Torque Off/Drive enable	STO 1	0 to +24 Vdc
41	Status relay (drive OK)	Normally open contact	2 A, 240 Vac, 0.5 A, 30 Vdc inductive load
42			
51 †	0V common	Common for backup supply	
52 †	+24 Vdc external supply	Backup control supply	24 Vdc, 40 W

Notes

* C300 uses STO, so terminal 11 is unassigned

** Frames 1 to 4 (Frames 5 to 9) - different terminals by frame size

Frames 1 to 4 - the 0V terminals on the Safe Torque Off are isolated from each other and the 0V common

Frames 5 to 9 - the 0V terminals on the Safe Torque Off are not isolated from each other and the 0V common

The Safe Torque Off / Drive enable terminal is a positive logic only input

† Terminal 51 and 52 must be connected to an external 24 V power supply if backup is required (frame sizes 6-9 only)

COMMANDER C

ORDERING GUIDE

How to select a drive

Electrical Considerations

- What is the supply voltage?
- Single or three phase input power?
- What is the motor rating?
- Continuous current – FLA (Full Load Amps)
- Select the drive based on motor Amps rather than power rating

Drive Mechanical Mounting

- Panel mounting – as standard
- Wall mounting – UL conduit kits are available
- Through panel mounting – frames 5 and up



Frame size	Dimensions H x W x D mm (in)	Weight kg (lb)
1	160 x 75 x 130 (6.3 x 2.95 x 5.1)	0.75 (1.65)
2	205 x 75 x 150 (8.07 x 2.95 x 5.9)	1.3 (3.0)
3	226 x 90 x 160 (8.9 x 3.54 x 6.3)	1.5 (3.3)
4	277 x 115 x 175 (10.9 x 4.5 x 6.9)	3.13 (6.9)
5	391 x 143 x 200 (15.39 x 5.63 x 7.87)	7.4 (16.3)
6	391 x 210 x 227 (15.39 x 8.27 x 8.94)	14 (30.9)
7	557 x 270 x 280 (21.93 x 10.63 x 11.02)	28 (61.70)
8	804 x 310 x 290 (31.65 x 12.21 x 11.42)	52 (114.6)
9E	1069 x 310 x 290 (42.09 x 12.21 x 11.42)	46 (101.4)
9A	1108 x 310 x 290 (43.62 x 12.21 x 11.42)	66.5 (146.6)



COMMANDER C

PRODUCT CODES

C200-	03	4	00073	A	-	101	00	AB100
⋮	⋮	⋮	⋮	⋮	⋮	⋮	⋮	⋮
Model:	Frame Size		Current Rating:			Control Version:		Product Variant:
C200 – Without STO C300 – With Dual STO	1 to 9		Heavy Duty current rating x 10			101 – C200 or C300 141 – C300PM		AB100- Standard KL000 – Laundry Drive
	Voltage Rating:			Drive Format:			Regional Default Setting:	
	1: 100 V drive (100 V to 120 V ±10 %)			A – AC in AC out			00 – 50 Hz	
	2: 200 V drive (200 V to 240 V ±10 %)			E – AC in AC out, External line reactor			01 – 60 Hz	
	4: 400 V drive (380 V to 480 V ±10 %)							
	5: 575 V drive (500 V to 575 V ±10 %)							
	6: 690 V drive (500 V to 690 V ±10 %)							

Note: For the STO variants just replace the C200 digits at the start of the part number with C300.

COMMANDER C

MODEL NUMBER AND RATINGS

Product Code	Supply Phases	Frame Size	Heavy Duty			Normal Duty		
			Max Continuous Current (A)	Motor Shaft Power (kW)	Motor Shaft Power (hp)	Max Continuous Current (A)	Motor Shaft Power (kW)	Motor Shaft Power (hp)
100/120 Vac +/-10%								
C200-01100017A10100AB100	1	01	1.7	0.25	0.33			
C200-01100024A10100AB100	1	01	2.4	0.37	0.5			
C200-02100042A10100AB100	1	02	4.2	0.75	1			
C200-02100056A10100AB100	1	02	5.6	1.1	1.5			
200/240 Vac +/-10%								
C200-01200017A10100AB100	1	01	1.7	0.25	0.33			
C200-01200024A10100AB100	1	01	2.4	0.37	0.5			
C200-01200033A10100AB100	1	01	3.3	0.55	0.75			
C200-01200042A10100AB100	1	01	4.2	0.75	1			
C200-02200024A10100AB100	1 3	02	2.4	0.37	0.5			
C200-02200033A10100AB100	1 3	02	3.3	0.55	0.75			
C200-02200042A10100AB100	1 3	02	4.2	0.75	1			
C200-02200056A10100AB100	1 3	02	5.6	1.1	1.5			
C200-02200075A10100AB100	1 3	02	7.5	1.5	2			
C200-03200100A10100AB100	1 3	03	10	2.2	3			
C200-04200133A10100AB100	1 3	04	13.3	3	3			
C200-04200176A10100AB100	3	04	17.6	4	5			
C200-05200250A10100AB100	3	05	25	5.5	7.5	30	7.5	10
C200-06200330A10100AB100	3	06	33	7.5	10	50	11	15
C200-06200440A10100AB100	3	06	44	11	15	58	15	20
C200-07200610A10100AB100	3	07	61	15	20	75	18.5	25
C200-07200750A10100AB100	3	07	75	18.5	25	94	22	30
C200-07200830A10100AB100	3	07	83	22	30	117	30	40
C200-08201160A10100AB100	3	08	116	30	40	149	37	50
C200-08201320A10100AB100	3	08	132	37	50	180	45	60
C200-09201760A10100AB100	3	09	176	45	60	216	55	75
C200-09202190A10100AB100	3	09	219	55	75	266	75	100
C200-09201760E10100AB100	3	09	176	45	60	216	55	75
C200-09202190E10100AB100	3	09	219	55	75	266	75	100
380/480 Vac +/- 10%								
C200-02400013A10100AB100	3	02	1.3	0.37	0.5			
C200-02400018A10100AB100	3	02	1.8	0.55	0.75			
C200-02400023A10100AB100	3	02	2.3	0.75	1			
C200-02400032A10100AB100	3	02	3.2	1.1	1.5			

For Normal Duty applications, use Heavy Duty ratings.

For Normal Duty applications, use Heavy Duty ratings.

For Normal Duty applications, use Heavy Duty ratings.

C200-02400041A10100AB100	3	02	4.1	1.5	2				
C200-03400056A10100AB100	3	03	5.6	2.2	3				
C200-03400073A10100AB100	3	03	7.3	3	3				
C200-03400094A10100AB100	3	03	9.4	4	5				
C200-04400135A10100AB100	3	04	13.5	5.5	7.5				
C200-04400170A10100AB100	3	04	17	7.5	10				
C200-05400270A10100AB100	3	05	27	11	20	30	15	20	
C200-05400300A10100AB100	3	05	30	15	20	30	15	20	
C200-06400350A10100AB100	3	06	35	15	25	38	18.5	25	
C200-06400420A10100AB100	3	06	42	18.5	30	48	22	30	
C200-06400470A10100AB100	3	06	47	22	30	63	30	40	
C200-07400660A10100AB100	3	07	66	30	50	79	37	60	
C200-07400770A10100AB100	3	07	77	37	60	94	45	60	
C200-07401000A10100AB100	3	07	100	45	75	112	55	75	
C200-08401340A10100AB100	3	08	134	55	100	155	75	100	
C200-08401570A10100AB100	3	09	157	75	125	184	90	150	
C200-09402000A10100AB100	3	09	200	90	150	221	110	150	
C200-09402240A10100AB100	3	09	224	110	150	266	132	200	
C200-09402000E10100AB100	3	09	200	90	150	221	110	150	
C200-09402240E10100AB100	3	09	224	110	150	266	132	200	
500/575 Vac +/-10%									
C200-05500030A10100AB100	3	05	3	1.5	2	3.9	2.2	3	
C200-05500040A10100AB100	3	05	4	2.2	3	6.1	4	5	
C200-05500069A10100AB100	3	05	6.9	4	5	10	5.5	7.5	
C200-06500100A10100AB100	3	06	10	5.5	7.5	12	7.5	10	
C200-06500150A10100AB100	3	06	15	7.5	10	17	11	15	
C200-06500190A10100AB100	3	06	19	11	15	22	15	20	
C200-06500230A10100AB100	3	06	23	15	20	27	18.5	25	
C200-06500290A10100AB100	3	06	29	18.5	25	34	22	30	
C200-06500350A10100AB100	3	06	35	22	30	43	30	40	
C200-07500440A10100AB100	3	07	44	30	40	53	45	50	
C200-07500550A10100AB100	3	07	55	37	50	73	55	60	
C200-08500630A10100AB100	3	08	63	45	60	86	75	75	
C200-08500860A10100AB100	3	08	86	55	75	108	90	100	
C200-09501040A10100AB100	3	09	104	75	100	125	110	125	
C200-09501310A10100AB100	3	09	131	90	125	155	110	150	
C200-09501040E10100AB100	3	09	104	75	100	125	110	125	
C200-09501310E10100AB100	3	09	131	90	125	155	110	150	
500/690 Vac +/-10%									
C200-07600190A10100AB100	3	07	19	15	20	23	18.5	25	
C200-07600240A10100AB100	3	07	24	18.5	25	30	22	30	
C200-07600290A10100AB100	3	07	29	22	30	36	30	40	
C200-07600380A10100AB100	3	07	38	30	40	46	37	50	
C200-07600440A10100AB100	3	07	44	37	50	52	45	60	
C200-07600540A10100AB100	3	07	54	45	60	73	55	75	
C200-08600630A10100AB100	3	08	63	55	75	86	75	100	
C200-08600860A10100AB100	3	08	86	75	100	108	90	125	
C200-09601040A10100AB100	3	09	104	90	125	125	110	150	
C200-09601310A10100AB100	3	09	131	110	150	155	132	175	
C200-09601040E10100AB100	3	09	104	90	125	125	110	150	
C200-09601310E10100AB100	3	09	131	110	150	155	132	175	



For Normal Duty applications, use Heavy Duty ratings.

Note:
 The listed ordering codes are for C200, 50 Hz default setting.
 For C300 change the model digits (C200-xxxxxxxxxxxxxxxx) from C200 to C300.
 For C300PM, change the control version digits to 141 and the model to C300: (C300-xxxxxxxx141xxxxxx).
 For 60 Hz change the Regional Default Setting digits (xxxx-xxxxxxxxxx00xxxx) from 00 to 01.





ACCESSORIES

ORDERING GUIDE

Optional keypad Order code

Remote Keypad		82500000000001
Remote keypad RTC		82400000019600

Optional accessories Order code

AI-Back-up Adaptor		82500000000004
AI-Smart Adaptor		82500000018500
RS485 cable		4500-0096
AI-485 24 V Adaptor		82500000019700

SI option modules Order code

(available from frame size 2 and upwards)

SI-EtherCAT		82400000018000
SI-PROFIBUS		82400000017500
SI-Ethernet		82400000017900
SI-DeviceNet		82400000017700
SI-CANopen		82400000017600
SI-PROFINET		82500000018200
SI-I/O		82400000017800
SI-POWERLINK		82400000021600

Through hole IP65 kit*

Frame Size	Order Code
5	3470-0067
6	3470-0055
7	3470-0079
8	3470-0083
9A	3470-0119
9E	3470-0105

Finger-guard grommet

Frame Size	Order Code
9A / 9E	3470-0107

Line reactor

Frame Size	Order Code
9E (400 V)	7022-0063

Lifting tool

Frame Size	Order Code
9A	7778-0045
9E	7778-0016

Fan replacement kit

Frame Size	Order Code
1	3470-0092
2	3470-0095
3	3470-0099
4	3470-0103

*IP65 / UL TYPE 12 rating is achieved on the rear of the drive when through panel mounted using the following kits.

**These mounting brackets ensure the drive can be mounted on existing Commander SK installations.

***Commander C built-in EMC filter complies with EN/IEC 61800-3. External EMC filters are required for compliance with EN/IEC 61000-6-4 as per the table below.

UL Type 1 conduit kit

Frame Size	Order Code
1	3470-0091
2	3470-0094
3	3470-0098
4	3470-0102
5	3470-0069
6	3470-0059
7	3470-0080
8 / 9A	3470-0088
9E	3470-0115

Retrofit kit**

Frame Size	Order Code
3	3470-0097
4	3470-0101
5	3470-0066
6	3470-0074
7	3470-0078
8	3470-0087
9A / 9E	3470-0118

Optional external EMC filters***

Frame Size	Voltage	Phases	Type	Order code	
1	All	1	Standard	4200-1000	
	All	1	Low leakage	4200-1001	
2	100V	1	Standard	4200-2000	
		1	Standard	4200-2001	
		1	Low leakage	4200-2002	
		3	Standard	4200-2003	
	200V	3	Low leakage	4200-2004	
		3	Standard	4200-2005	
		3	Low leakage	4200-2006	
		1	Standard	4200-3000	
3	200V	1	Low leakage	4200-3001	
		3	Standard	4200-3004	
		3	Low leakage	4200-3005	
		3	Standard	4200-3008	
	400V	3	Low leakage	4200-3009	
		1	Standard	4200-4000	
		1	Low leakage	4200-4001	
		3	Standard	4200-4002	
4	200V	3	Low leakage	4200-4003	
		3	Standard	4200-4004	
		3	Low leakage	4200-4005	
		200V	3	Standard	4200-0312
	400V	3	Standard	4200-0402	
		200V	3	Standard	4200-2300
		400V	3	Standard	4200-4800
		200V & 400V	3	Standard	4200-1132
5	200V & 400V	3	Standard	4200-1972	
	200V & 400V	3	Standard	4200-3021	

DRIVE OBSESSED



Control Techniques has been designing and manufacturing the best variable speed drives in the world since 1973.

Our customers reward our commitment to building drives that outperform the market. They trust us to deliver on time every time with our trademark outstanding service.

More than 50 years later, we're still in pursuit of the best motor control, reliability and energy efficiency you can build into a drive. That's what we promise to deliver, today and always.

1.6K+

Employees

70

Countries

#1 FOR ADVANCED

MOTOR AND DRIVE TECHNOLOGY



Nidec Corporation is a global manufacturer of electric motors and drives.

Nidec was set up in 1973. The company made small precision AC motors and had four employees. Today, it's a global corporation that develops, builds and installs cutting-edge drives, motors and control systems in over 40 countries with a workforce of more than 114,000.

You'll find its innovations in thousands of industrial plants, IoT products, home appliances, cars, robotics, mobile phones, haptic devices, medical apparatus and IT equipment all over the world.

114K

Employees

\$17.4B

Group Turnover

40+

Countries

300+

Companies



CONTROL TECHNIQUES. NO ONE KNOWS DRIVES LIKE WE DO.

Our drive obsessive representatives will drive you in the right direction and give you first class support whenever you need it.

For more information, or to find your local drive centre, visit:

www.controltechniques.com

Connect with us



©2024 Nidec Control Techniques Limited. The information contained in this brochure is for guidance only and does not form part of any contract. The accuracy cannot be guaranteed as Nidec Control Techniques Ltd have an ongoing process of development and reserve the right to change the specification of their products without notice.

Nidec Control Techniques Limited. Registered Office: The Gro, Newtown, Powys SY16 3BE.

Registered in England and Wales. Company Reg. No. 01236886.

P.N.0778-0509-07 01/24

