



PNEUMATIC FITTINGS AND TUBE

[www.sang-a.it](http://www.sang-a.it)



**Sang-A**

# ONE-TOUCH FITTINGS

## Application

- One-touch joints used in pneumatic piping.
- Used for a wide variety of models to meet all needs.

## Feature

- Easy to connect/disconnect tube by one touch.
- PC type is useful for piping in confined space, given its six-angle wrench processing inside.
- Elliptical sleeve makes it possible to apply and remove the tube easily in confined space.
- Fittings are equipped with a Gasket, O-ring and Teflon-Treatment already on the thread.

## Specification

Fluid	Air (No other gases or liquids)	
Working Pressure Range	0~290PSI	0~20Kgf/cm <sup>2</sup> (0~2000kPa)
Negative Pressure	-29.5 in Hg	-750mmHg(10Torr)
Temperature Range	32~140°F	0 ~ 60 °C
Applicable Tube Material	Polyurethane and Nylon	

## Structural Diagram

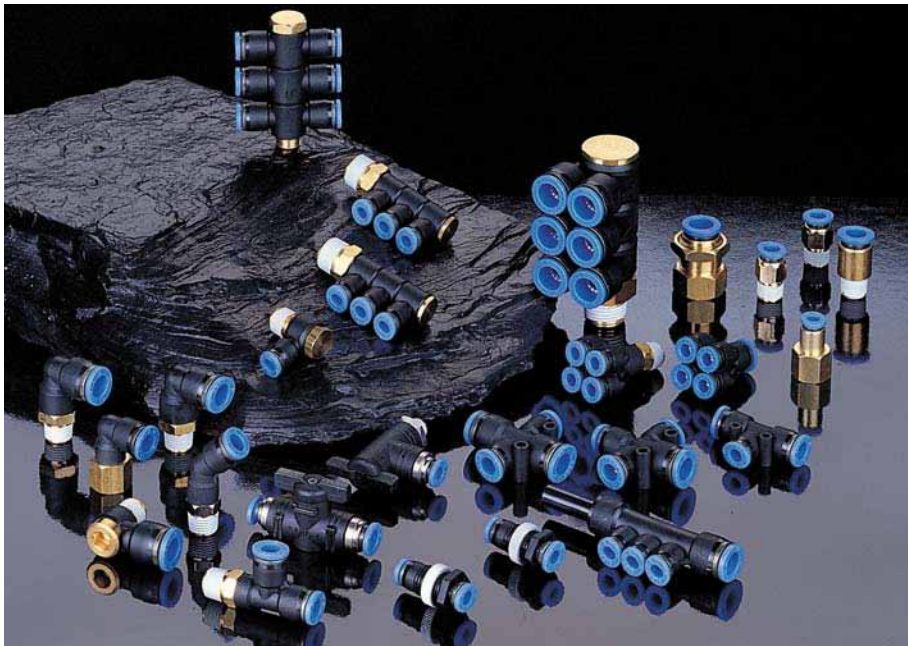
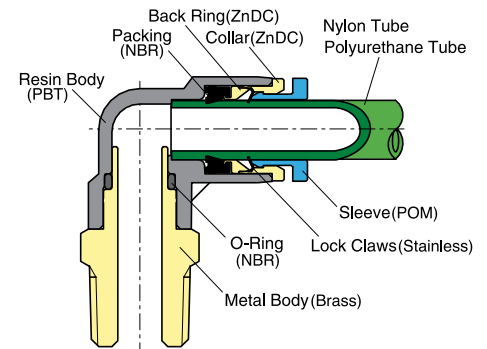

## Case In Use

### ►POC Model

- The hexagonal hole of the inside body makes it possible to tighten the fitting with a hexagonal wrench.
- A hexagonal wrench must be used due to the round exterior.

### ►PL Model

- Flexible for directional tube laying given its revolving construction of body (PL and PT type)

### ►Elliptical Sleeve

- Elliptical sleeve makes it possible to apply and remove the tube easily in confined spaces.

## Product Code System

**PC O8-02**

① ② ③ ④

### ①Type

### ②Tube Dia(∅D)

	Metric Size								Inch Size					
Code	03	04	06	08	10	12	14	16	5/32	3/16	1/4	5/16	3/8	1/2
Dia	∅3	∅4	∅6	∅8	∅10	∅12	∅14	∅16	∅5/32	∅3/16	∅1/4	∅5/16	∅3/8	∅1/2

### ③Thread Size(T)

#### \* Metric Thread & R(PT) Thread

	Metric Size				Taper Pipe Thread			
Code	M3	M5	M6	01	02	03	04	
Size	M3×0.5	M5×0.8	M6×1.0	R1/8	R1/4	R3/8	R1/2	

#### \* Inch Thread (UNF & NPT)

	Unified Fine Thread		American Standard Taper Pipe Thread			
Code	U10U		N01U	N02U	N03U	N04U
Size	10-32UNF		NPT1/8	NPT1/4	NPT3/8	NPT1/2

### ④U-Hexagon flat-to-flat inch specification (NPT)

# One -Touch Fittings

<p><b>PC</b></p>  <p>Male Straight</p>	<p><b>PL</b></p>  <p>Male Elbow</p>	<p><b>PL45</b></p>  <p>Male 45° Elbow</p>	<p><b>PT</b></p>  <p>Male Branch Tee</p>	<p><b>PST</b></p>  <p>Male Run Tee</p>	<p><b>POC</b></p>  <p>Round Male Straight</p>	<p><b>PCF</b></p>  <p>Female Straight</p>
<p><b>PH</b></p>  <p>Male Banjo</p>	<p><b>PH(D2)</b></p>  <p>Double Universal Elbow</p>	<p><b>PH(D3)</b></p>  <p>Triple Universal Elbow</p>	<p><b>PHF</b></p>  <p>Female Banjo</p>	<p><b>PWT</b></p>  <p>Male Y</p>	<p><b>PMF</b></p>  <p>Bulkhead Female Straight</p>	<p><b>PCJ</b></p>  <p>Plug-In Male</p>
<p><b>PLF</b></p>  <p>Female Elbow</p>	<p><b>PTF</b></p>  <p>Female Branch Tee</p>	<p><b>POL</b></p>  <p>Hex. Holed Banjo</p>	<p><b>PLL</b></p>  <p>Extended Male Elbow</p>	<p><b>PLLJ</b></p>  <p>Union Straight</p>	<p><b>PUC</b></p>  <p>Union Straight</p>	<p><b>PUL</b></p>  <p>Union Elbow</p>
<p><b>PUT</b></p>  <p>Union Tee</p>	<p><b>PY</b></p>  <p>Union Y</p>	<p><b>PG</b></p>  <p>Reducer</p>	<p><b>PUG</b></p>  <p>Different Dia of Union Tee</p>	<p><b>PW</b></p>  <p>Reducer Y</p>	<p><b>PZA</b></p>  <p>Union Cross</p>	<p><b>PZA22</b></p>  <p>Different Dia of Union Cross(2/2)</p>
<p><b>PZA31</b></p>  <p>Different Dia of Union Cross(3/1)</p>	<p><b>PMM</b></p>  <p>Bulkhead Union</p>	<p><b>PPM</b></p>  <p>Bulkhead Union P</p>	<p><b>PLM</b></p>  <p>Bulkhead Union P</p>	<p><b>PCP</b></p>  <p>Straight Ace Coupler Plug</p>	<p><b>PA</b></p>  <p>Dual Male Banjo</p>	<p><b>PA(D2)</b></p>  <p>Double Branch A</p>
<p><b>PA(D3)</b></p>  <p>Triple Branch A</p>	<p><b>PAF</b></p>  <p>Dual Female Banjo</p>	<p><b>PGJ</b></p>  <p>Plug-In Reducer</p>	<p><b>PLJ</b></p>  <p>Plug-In Elbow</p>	<p><b>PLJ45</b></p>  <p>Plug-In Extended Elbow</p>	<p><b>PLLJ</b></p>  <p>Plug-In Extended Elbow</p>	<p><b>PLLJ45</b></p>  <p>Plug-In Reducer Elbow</p>
<p><b>PLGJ</b></p>  <p>Plug-In Reducer Elbow</p>	<p><b>PLGJ45</b></p>  <p>Plug-In Reducer Elbow</p>	<p><b>PIJ</b></p>  <p>Tube Splicer</p>	<p><b>PJH</b></p>  <p>Plug-In Extended Elbow</p>	<p><b>PIG</b></p>  <p>Reducer Tube Splicer</p>	<p><b>PP</b></p>  <p>Plug</p>	<p><b>PYJ</b></p>  <p>Plug-In Y</p>



<p><b>PWJ</b></p>  <p>Plug-In Reducer Y</p>	<p><b>PPF</b></p>  <p>Cap</p>	<p><b>PXG</b></p>  <p>Reducer Double Y Union</p>	<p><b>PXJ</b></p>  <p>Reducer Double Y</p>	<p><b>PXT</b></p>  <p>Male Double Y</p>	<p><b>PKG</b></p>  <p>Reducer Triple Branch Union</p>	<p><b>PKJ</b></p>  <p>Plug-In Reducer Triple Branch</p>
<p><b>PKD</b></p>  <p>Male Reducer Triple Branch</p>	<p><b>CAS</b></p>  <p>Insert-Tube</p>	<p><b>CASI</b></p>  <p>Insert-Tube Clip</p>				

## Fitting with G Thread (O-Ring)

<p><b>PC-G</b></p>  <p>Male Straight</p>	<p><b>PL-G</b></p>  <p>Male Elbow</p>	<p><b>PL45-G</b></p>  <p>Male 45° Elbow</p>	<p><b>PT-G</b></p>  <p>Male Branch Tee</p>	<p><b>PST-G</b></p>  <p>Male run Tee</p>	<p><b>POC-G</b></p>  <p>Male run Tee</p>	<p><b>PCF-G</b></p>  <p>Female Straight</p>
<p><b>PH-G</b></p>  <p>Female Banjo</p>	<p><b>PH-G (D2)</b></p>  <p>Double Universal Elbow</p>	<p><b>PH-G (D3)</b></p>  <p>Triple Universal Elbow</p>	<p><b>PHF-G</b></p>  <p>Female Banjo</p>	<p><b>PHF-GG</b></p>  <p>Female Banjo</p>	<p><b>PWT-G</b></p>  <p>Male Y</p>	<p><b>PMF-G</b></p>  <p>Bulkhead Female Straight</p>
<p><b>PLF-G</b></p>  <p>Female Elbow</p>	<p><b>POL-G</b></p>  <p>Extended Male Elbow</p>	<p><b>PLL-G</b></p>  <p>Extended Male Elbow</p>	<p><b>PLL-P-G</b></p>  <p>Extended Male Elbow</p>	<p><b>PA-G (D2)</b></p>  <p>Double Branch A</p>	<p><b>PA-G (D3)</b></p>  <p>Triple Branch A</p>	<p><b>PAF-G</b></p>  <p>Dual Female Banjo</p>
<p><b>PXT-G</b></p>  <p>Male Double Y</p>	<p><b>PKD-G</b></p>  <p>Male Reducer Triple Branch</p>	<p><b>PGL-G (D1)</b></p>  <p>Single Universal Elbow</p>	<p><b>PGL-G (D2)</b></p>  <p>Double Universal Elbow</p>	<p><b>PGL-G (D3)</b></p>  <p>Triple Universal Elbow</p>	<p><b>PGT-G (D1)</b></p>  <p>Single Universal Elbow</p>	<p><b>PGT-G (D2)</b></p>  <p>Double Universal Tee</p>
<p><b>PGT-G (D3)</b></p>  <p>Triple Universal Tee</p>	<p><b>PGB(D1)</b></p> 	<p><b>PGB(D2)</b></p> 	<p><b>PGB(D3)</b></p> 	<p><b>PGL</b></p> 	<p><b>PGT</b></p> 	<p><b>PGO</b></p> 

# COMPACT ONE-TOUCH FITTINGS

## Application

- Compact type one-touch joints used in small types of pneumatic piping.
- A wide variety of models are available to meet most your needs.

## Feature

- The world's smallest quick-fitting joints feature 40% smaller volume ratio and 20% smaller O.D. ratio in comparison to the conventional type.
- The compact type joints, which are nickel plated, are excellent not only in appearance but also in rust resistance.
- The elliptical sleeve helps easy application or removal of the tube in confined space.

## Specification

Fluid	Air(No other gases or liquids)	
Working Pressure Range	0~150PSI	0~9Kgf/cm <sup>2</sup> (0~900kPa)
Negative Pressure	-29.50 in Hg	-750mmHg(10Torr)
Temperature Range	32~140° F	0~60° C
Applicable Tube Material	Polyurethane and Nylon	

## Structural Diagram

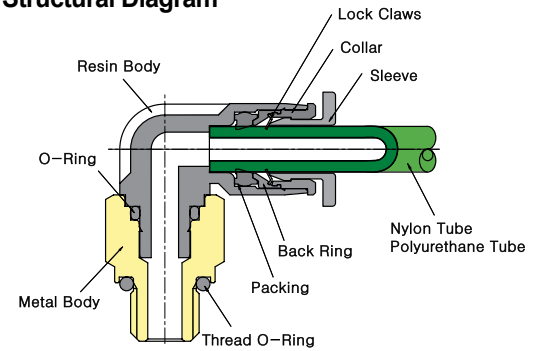

## Case In Use

### ►POC Model/PCC Model

The hexagonal shape on the inside of the body makes it possible to tighten the fitting by use of a hexagonal wrench. In the case of POC, PCC a hexagonal wrench must be used due to the round exterior.

### ►PLL Model/PL Model

Long brass body helps tightening with ease away from any obstacles.

## Product Code System

# PC 06-01 C

①      ②      ③      ④

① Type

② Tube Dia( ØD)

	Metric Size			Inch Size		
Code	03	04	06	5/32	3/16	1/4
Dia	Ø3	Ø4	Ø6	Ø5/32	Ø3/16	Ø1/4

③ Thread Size(T)

\* Metric Thread & R(PT) Thread

	Metric Size					
Code	M3	M5	M6	M7	M8	01
Size	M5 × 0.8	M5 × 0.8	M6 × 1.0	M7 × 1	M8 × 0.75	R1/8

④ C=COMPACT

# Compact One -Touch Fitting

<p><b>PC-C</b></p>  <p>Male Straight</p>	<p><b>PL-C</b></p>  <p>Male Elbow</p>	<p><b>PT-C</b></p>  <p>Male Branch Tee</p>	<p><b>POC-C</b></p>  <p>Round Male Straight</p>	<p><b>PUC-C</b></p>  <p>Union Straight</p>	<p><b>PUL-C</b></p>  <p>Union Straight</p>	<p><b>PUT-C</b></p>  <p>Union Tee</p>
<p><b>PCF-C</b></p>  <p>Female Straight</p>	<p><b>PST-C</b></p>  <p>Male Run Tee</p>	<p><b>PLL-C</b></p>  <p>Extended Male Elbow</p>	<p><b>PGJ-C</b></p>  <p>Reducer</p>	<p><b>PW-C</b></p>  <p>Reducer Y</p>	<p><b>PWJ-C</b></p>  <p>Plug-In Reducer Y</p>	<p><b>PLJ-C</b></p>  <p>Plug-In Elbow</p>
<p><b>PMM-C</b></p>  <p>Bulkhead Union</p>	<p><b>PCC-C</b></p>  <p>Round Male Straight</p>	<p><b>PPF-C</b></p>  <p>Cap</p>	<p><b>PZA-C</b></p>  <p>Union Cross</p>	<p><b>PYJ-C</b></p>  <p>Plug -In Y</p>	<p><b>PG-C</b></p>  <p>Reducer</p>	<p><b>PY-C</b></p>  <p>Union Y</p>
<p><b>PP-C</b></p>  <p>Plug</p>	<p><b>PLM-C</b></p>  <p>Bulkhead Union P</p>					

## Fitting with G Thread (O-Ring)

<p><b>PC-C(G)</b></p>  <p>Male Straight</p>	<p><b>PL-C(G)</b></p>  <p>Male Elbow</p>	<p><b>PT-C(G)</b></p>  <p>Male Branch Tee</p>	<p><b>POC-C(G)</b></p>  <p>Round Male Straight</p>	<p><b>PST-C(G)</b></p>  <p>Male Run Tee</p>	<p><b>PLL-C(G)</b></p>  <p>Extended Male Elbow</p>
--	---	--	---	---	---

# SPEED CONTROLLERS

## Application

- Valve used for controlling the operation speed of a driving device.
- Used for movement of machines such as cylinder, pneumatic finger, etc.

## Feature

- Precisely permit the optimal rate of airflow for the smooth cylinder movement of driving devices.
- The Compact and light body permits use in confined space.
- Uni-directional airflow is available for either exhaust or inlet flow control methods.
- The compact design provides a comparable range of speed as the conventional speed controllers do.

## Specification

Fluid	Air(No other gases or liquids)	
Working Pressure Range	0~290PSI	0~20Kgf/cm <sup>2</sup> (0~2000kPa)
Negative Pressure	7.5PSI	0.5Kgf/cm <sup>2</sup> (50kPa)
Temperature Range	32~140° F	0~60° C
Applicable Tube Material	Polyurethane and Nylon	

## Structural Diagram

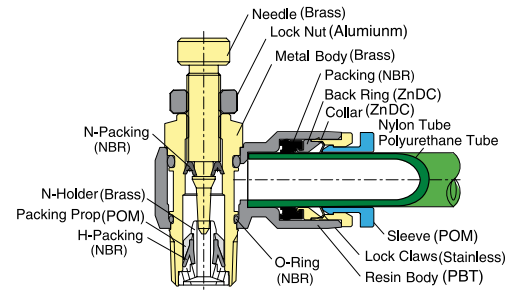

## Product Code System

**NSE O8-O2 O U**

① ② ③ ④ ⑤

① Type

② Tube Dia(∅D)

Code	Metric Size						Inch Size						
	03	04	06	8	10	12	1/8	5/32	3/16	1/4	5/16	3/8	1/2
Dia	∅3	∅4	∅6	∅8	∅10	∅12	∅1/8	∅5/32	∅3/16	∅1/4	∅5/16	∅3/8	∅1/2

③ Thread Size(T)

\*Metric Thread & R(PT) Thread

Code	Metric Size			Taper Pipe Thread			
	M3	M5	01	02	03	04	
Size	M3×0.5	M5×0.8	R1/8	R1/4	R3/8	R1/2	

\*Inch Thread (UNF & NPT)

Code	Unified Fine Thread		American Standard Taper Pipe Thread			
	U10U		N01U	N02U	N03U	N04U
Size	10-32UNF		NPT1/8	NPT1/4	NPT3/8	NPT1/2

④ Control Method

Type	Meter out		Meter in	
	Standard Blue	Compact Black	Standard Red	Compact Red
Symbol				

⑤U : Hexagon flat-to-flat inch specification.(NPT)



# Speed Controllers



## Fitting with G Thread (O-Ring)

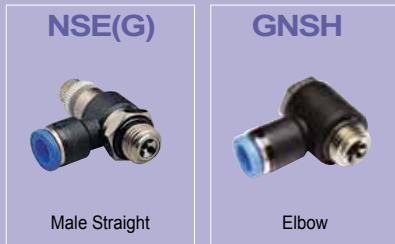

### Case In Use

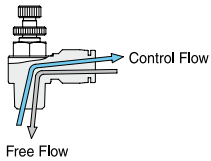

#### ►Out-Type

- The way to control of airflow from the thread to the sleeve.
- Air passes freely from the sleeve to the thread.

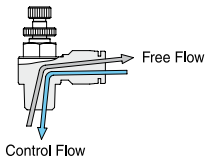

#### ►In-Type

- The way to control of airflow from the sleeve to the thread.
- Air passes freely from the thread to the sleeve.

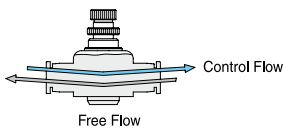

#### ►Flat-Type

- The way to control of Free Flow or Control Flow upon piping in accordance with the signal on the body.
- Air flows from each side of sleeve.

# ROTARY JOINTS

## Application

- Used for supplying compressed air at swiveling or swinging connections.
- Used for index tables and industrial robots.

## Feature

- Built in bearings, suitable for high-speed swiveling pneumatic connections..

## Specification

Fluid	Air(No other gases or liquids)	
Working Pressure Range	0~150PSI	0~9Kgf/cm <sup>2</sup> (0~900kPa)
Negative Pressure	-29.50 in Hg	-750mmHg(10Torr)
Temperature Range	32~140° F	0~60°C
Applicable Tube Material	Polyurethane and Nylon	

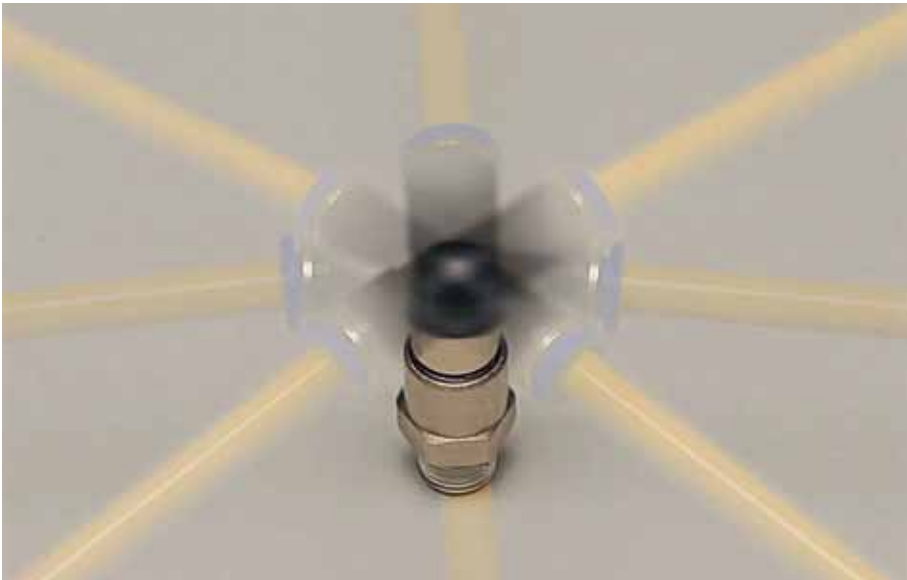

## Structural Diagram

### ▼High Rotary Joint

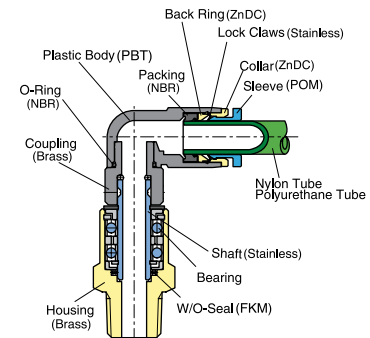

### ▼Rotary Joint

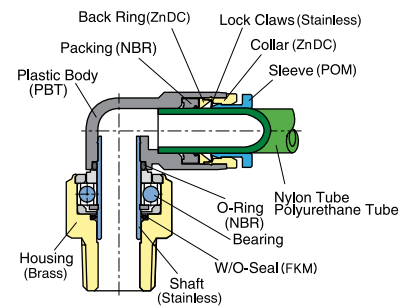

## Product Code System

**NHRC 06-01**

- ① Type      ②      ③

① Type

② Tube Dia(∅D)

Code	04	06	08	10	12
Dia	∅4	∅6	∅8	∅10	∅12

③ Thread Size(T)

	Metric Size		Taper Pipe Thread			
Code	M5	M6	01	02	03	04
Size	M5×0.8	M6×1.0	R1/8	R1/4	R3/8	R1/2

## Number of Rotations

		Tube Dia	∅4	∅6	∅8	∅10	∅12
r.p.m	Low	NRC, NRL	500	500	400	300	250
	High	NHRC, NHRL, NHRS, NHRF	1,500	1,200	1,200	1,000	1,000

# Rotary Joints

**NRC**



Straight

**NRL**



Elbow

**NHRC**



Straight

**NHRL**



Elbow

**NHRF**



Bush

**NHRS**



Nipple

## Fitting with G Thread (O-Ring)

**NRC-G**



Straight

**NRL-G**



Elbow

**NHRC-G**



Straight

**NHRL-G**



Elbow

**NHRF-G**



Bush

**NHRS-G**



Nipple

# STOP FITTINGS

## Application

- Installed where the pneumatic connections are changed frequently.
- Used at laboratory or for instructing pneumatic connections.

## Feature

- Upon disconnecting the tube, the airflow will stop.

## Specification

Fluid	Air(No other gases or liquids)	
Working Pressure Range	0~150PSI	0~9Kgf/cm(0~900kPa)
Negative Pressure	-29.5 in Hg	-750mmHg(10Torr)
Temperature Range	32~140° F	0~60°C
Applicable Tube Material	Polyurethane and Nylon	

## Structural Diagram

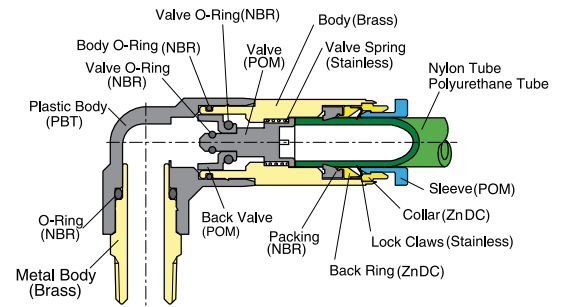

## Product Code System

**SPC 06-01**

① ② ③

① Type

② Tube Dia(  $\varnothing$ D)

Code	04	06	08	10	12
Dia	$\varnothing$ 4	$\varnothing$ 6	$\varnothing$ 8	$\varnothing$ 10	$\varnothing$ 12

③ Thread Size(T)

	Metric Size		Taper Pipe Thread			
Code	M5	M6	01	02	03	04
Size	M5 $\times$ 0.8	M6 $\times$ 1.0	R1/8	R1/4	R3/8	R1/2



# Stop Fittings

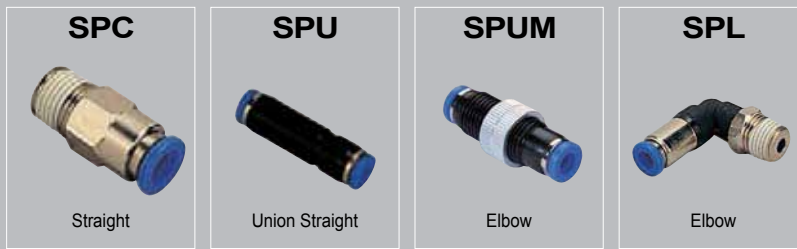

## Fitting with G Thread (O-Ring)

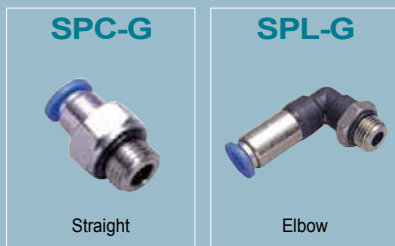

### Control Method

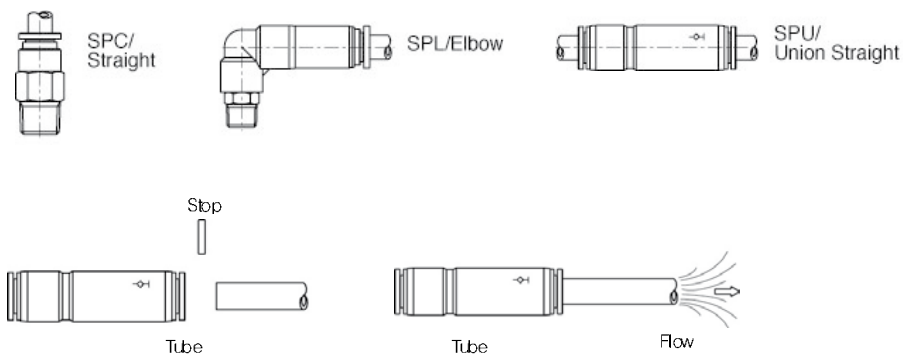

# CHECK VALVES

## Application

- Check Valves permit airflow in one direction.
- Used for maintaining the output pressure at a constant level.

## Feature

- The check valves permit the airflow in one direction but stops in the reverse direction.
- The check valve works at the pressure of 0.1kgf/cm<sup>2</sup>, keeps 1.42 PSI in vacuum and connects at a low pressure.

## Specification

Fluid	Air(No other gases or liquids)	
Working Pressure Range	0~150PSI	0~9Kgf/cm <sup>2</sup> (0~900kPa)
Negative Pressure	-29.50 in Hg	-750mmHg(10Torr)
Temperature Range	32~140° F	0~60° C
Applicable Tube Material	Polyurethane and Nylon	

## Product Code System

# PCVC 06-01 A

①      ②      ③      ④      ⑤





- ① Type  
② Tube Dia(∅D)

Code	04	06	08	10	12
Dia	∅4	∅6	∅8	∅10	∅12

- ③ Thread Size(T)

Code	Metric Size		Taper Pipe Thread			
	M5	M6	01	02	03	04
Size	M5 × 0.8	M6 × 1.0	R1/8	R1/4	R3/8	R1/2

- ④ Control Method

Type	Meter IN	Meter OUT
Air Flow	Thread to Tube	Tube to Thread
PCVC		
PCVF		
PCVU		In case of PCVU model, you should pipe according to signal of the body.

- ⑤ U : Hexagon flat-to-flat inch specification.(NPT)

## Structural Diagram

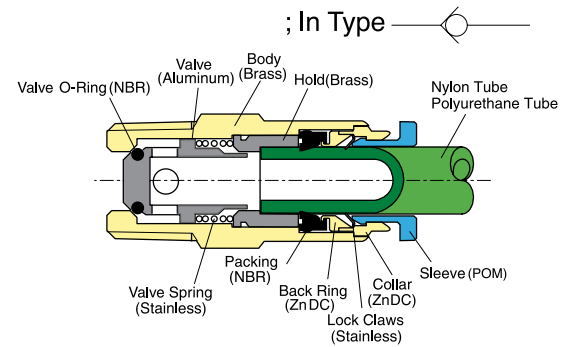

# Check Valves

**PCVC**



Straight

**PCVF**



Bush

**PCVU**

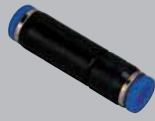

Union Straight

## Fitting with G Thread (O-Ring)

**PCVC-G**



Straight

**PCVF-G**



Bush

# BALL VALVES

## Application

- Used for controlling air supply in the opened and closed positions.

## Feature

- Available for water as well as air with PPS resin body.
- The sectional dimension of the compact body optimizes as much flow as the tube capacity in proportion.

## Specification

Fluid	Air & Water	
Working Pressure Range	0~150PSI	0~9Kg/cm <sup>2</sup> (0~900kPa)
Negative Pressure	-29.50 in Hg	-750mmHg(10Torr)
Temperature Range	32~140° F	0~60° C
Applicable Tube Material	Polyurethane and Nylon	

## Structural Diagram

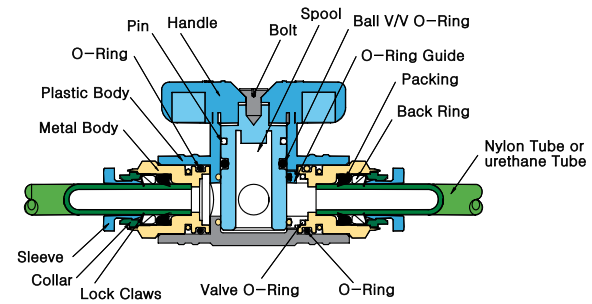

## Product Code System

**BC 20 - 08 02**

① ② ③ ④

① Type

② Effective Sectional Area

	Metric Size	
Code	20	60
Size	20 mm <sup>2</sup>	60 mm <sup>2</sup>

③ Tube Dia(∅D)

Code	06	08	10	12
Dia	∅6	∅8	∅10	∅12

④ Thread Size(T)

	Taper Pipe Thread			
Code	01	02	03	04
Size	R1/8	R1/4	R3/8	R1/2



# Ball Valves

**BUC**



Union

**BUG**



Reducing Union

**BM**



Bulkhead Union

**BL**



Elbow

**BC**



Straight

**BUL**



Union Elbow

**BLG**



Reducing  
Union Elbow

**BLM**



Bulkhead Union  
Elbow

## Fitting with G Thread (O-Ring)

**BL-G**



Elbow

**BC-G**



Straight

# HAND VALVES

## Application

- Used for turning air pressure on and off for pneumatic devices.

## Feature

- When off, the three-way direction control valve discharges the residual pressure and blocks air flow-in.

## Specification

Fluid	Air(No other gases or liquids)	
Working Pressure Range	0~150PSI	0~9Kgf/cm <sup>2</sup> (0~900kPa)
Negative Pressure	-29.50 in Hg	-750mmHg(10Torr)
Temperature Range	32~140 ° F	0~60 ° C
Applicable Tube Material	Polyurethane and Nylon	



## Structural Diagram

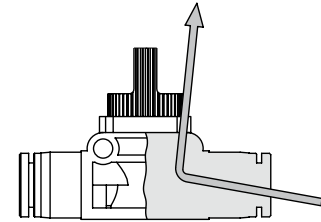
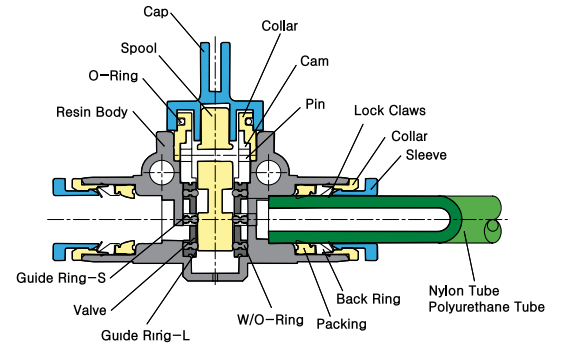

### ► 3 Way Direction, 2 Way Direction

- The three-way direction control valve, when the air is stopped, discharges residual pressure to the outlet, which assures safety in repairing or adjusting connected devices.
- The two-way direction control valve does not discharge residual pressure, and is suitable for a reservoir tank or other device that does not require a discharging residual pressure.
- The two-way direction control valve is also suitable for the system where a vacuum pipe is used.

## Product Code System

**HVFS 06 - 01**

①                      ②                      ③

① Type

② Tube Dia(∅D)

Code	06	08	10	12
Dia	∅6	∅8	∅10	∅12

③ Thread Size(T)

	Taper Pipe Thread			
Code	01	02	03	04
Size	R1/8	R1/4	R3/8	R1/2

# Hand Valves

**HVSS**



Nipple

**HVFS**



Straight Fitting Thread

**HVFF**



Union Straight

**HVSF**



Straight Thread-Fitting

## Fitting with G Thread (O-Ring)

**HVSS-G**



Nipple

**HVFS-G**



Straight Fitting Thread

**HVSF-G**



Straight Thread-Fitting

# TWO-TOUCH FITTING AND SILENCERS

## Application

- Nut-tightened air connector used for pneumatic piping.

## Feature

- Effective use at the place of vibration or rocking.
- Long life-span made of plastic.
- Excellent in anti-corrosion and anti-chemicals.

## Structural Diagram

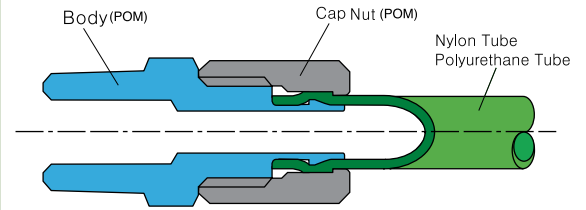

## Specification

Fluid	Air(No other gases or liquids)	
Working Pressure Range	0~150PSI	0~9Kgf/cm <sup>2</sup> (0~900kPa)
Negative Pressure	-29.50 in Hg	-750mmHg(10Torr)
Temperature Range	32~140 ° F	0~60° C
Applicable Tube Material	Polyurethane and Nylon	



## Product Code System

**TC 04 - 01**

①      ②      ③

### ① Type

Code	Metric Size				
	TC	TL	TUT	THT	THL
Type	STRAIGHT	ELBOW	UNION	TEE	ELBOW
	ROTATION				

### ② Tube Dia(∅D)

Code	04	06	08	10	12
Dia	∅4 × ∅2.5	∅6 × ∅4	∅8 × ∅5.5	∅10 × ∅6.5	∅12 × ∅8

### ③ Thread Size(T)

Code	Thread Size			
	01	02	03	04
Size	R1/8	R1/4	R3/8	R1/2



# Two -Touch Fitting



# Silencers

## Product Code System



**ST 01**

① ②

① Type

② Thread Size

Thread Size	Metric Thread	Tape Pipe Thread			
Code	M5	01	02	03	04
Size	M5	R1/8	R1/4	R3/8	R1/2

# TUBE CUTTER

## Application

- Safe, efficient, accurate tool for cutting tubing.

## Specification

Available Tube	Polyuethane and Nylon
Cutting Outer Dia	Ø3.0 ~ Ø12.0
Material	Polyacetal, Stainless steel
Standard Color	Blue

## Product Code System

**TC (TUBE CUTTER)**

MODEL	W.G(φ)	Q <sup>1</sup> ty/In-Box
Tube Cutter	30.5	24



# AIR GUN

## Application

- Used for installation on machines for cleaning debris and particles, best in confined space.

## Feature

- Various size of nozzle makes it easy to clean the machines and the equipment.
- Easy control of airflow volume.

## Structural Diagram

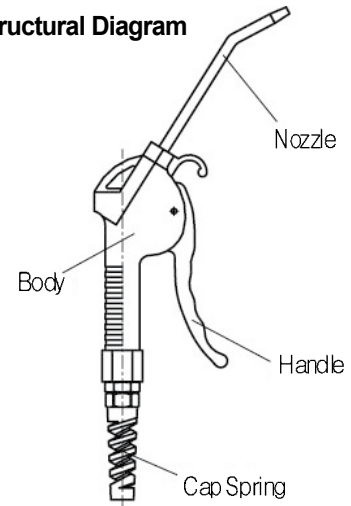

## Specification

Fluid	Air(No other gases or liquids)	
Working Pressure Range	15~150PSI	1~9.9Kgf/cm <sup>2</sup> (0~990kPa)
Temperature Range	32~140 ° F	0~60 ° C

## Product Code System

**AG - 08 - 02 - S - B**

①      ②      ③      ④      ⑤

① Type

② Tube Dia(∅D)

	Metric Size	
Code	08	10
Dia	∅8	∅10

③ Thread Size (Rc)

	Metric Size	
Code	02	03
Dia	Rc1/4	Rc3/8

④ Nozzle Size

Type	Metric Size					
	Nozzle			Nozzle-Coupler		
Size	S	M	L	SP	MP	LP
	Short	Medium	Long	Short	Medium	Long

⑤ Color

B	R	BU
Black	Red	Blue



## Air Gun



## Case In Use

Convenient to clean dangerous parts and to remove foreign substances from the machine(CNC LATHE, AUTOMATIC LATHE, CATAPLUT and PRESS)

# POLYURETHANE TUBE

## Application

- Used for industrial robots and pneumatic piping.
- Used for various applications by functions.

## Feature

- Higher flexibility than nylon(PA) helps working achievement.
- Higher flexibility in low temperature.

## Specification

Fluid	Air(No other gases or liquids)	
Working Pressure Range	0~150PSI	0~9Kgf/cm <sup>2</sup> (0~900kPa)
Negative Pressure	-29.50 in Hg	-750mmHg(10Torr)
Temperature Range	32~140° F	-15~60 °C

## Product Code System

**U - 08 - 50 - B**

① ② ③ ④

**UC - 08 - 50 - 05 - Y**

① ② ③ ⑤ ④

### ① Type

### ②③ Tube Dia(∅D)

Code	Metric Size								
	0320	0420	0425	0640	0850	0855	1065	1290	1611
Outer Dia	∅3	∅4	∅4	∅6	∅8	∅8	∅10	∅12	∅16
Inner Dia	∅2	∅2	∅2.5	∅4	∅5	∅5.5	∅6.5	∅9	∅11

Code	Inch Size							
	1/8	5/32	3/16	1/4	5/16	3/8	1/2	5/8
Outer Dia	∅1/8	∅5/32	∅3/16	∅1/4	∅5/16	∅3/8	∅1/2	∅5/8

### ④ Color

	C	BK	R	Bu	Y	G	W	O
Color	Clear	Black	Red	Blue	Yellow	Green	White	Orange

### ⑤ Length(m)

## Working Pressure

- Temperature limits of tube : -40°C ~80°C
- Normal Pressure : Control normal pressure within 1/3 of tube burst pressure.

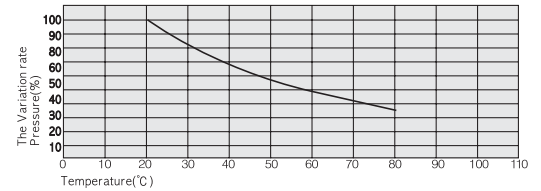

**U**



MODEL [OUT-IN]

**Metric Size**

MODEL	O. D(mm)	I D(mm)
U-03020	3	2
U-04025	4	2.5
U-06040	6	4
U-08050	8	5
U-08055	8	5.5
U-10065	10	6.5
U-12090	12	9
U-16110	16	11

**UC**

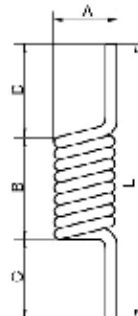

MODEL [OUT-Length]

**Metric Size**

MODEL	O. D(mm)	I D(mm)	Length(m)
UC-0402-15	4	2	1.5
UC-0402-30	4	2	3
UC-0402-45	4	2	4.5
UC-0604-15	6	4	1.5
UC-0604-30	6	4	3
UC-0604-45	6	4	4.5
UC-0805-35	8	5	3.5
UC-0805-50	8	5	5
UC-0805-75	8	5	7.5
UC-0805-100	8	5	10
UC-1065-35	10	6.5	3.5
UC-1065-50	10	6.5	5
UC-1065-75	10	6.5	7.5
UC-1065-100	10	6.5	10
UC-1208-35	12	8	3.5
UC-1208-50	12	8	5
UC-1208-75	12	8	7.5
UC-1208-100	12	8	10



Via Garavina, 2 - Località Piusso - 23016 Cercino (SO)  
tel. +39 0342 681298 - fax +39 0342 680004  
info@sang-a.it - **www.sang-a.it**

ITALIAN IMPORTER:



**VAL-PO-CI**  
info@valpoci.it - **www.valpoci.it**