

Single-Beam Area Sensors

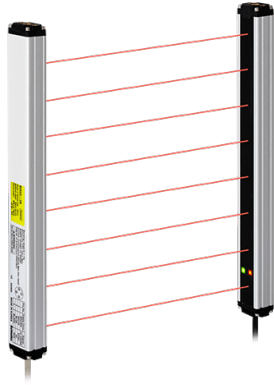

BW Series PRODUCT MANUAL

For your safety, read and follow the considerations written in the instruction manual, other manuals and Autonics website.

The specifications, dimensions, etc. are subject to change without notice for product improvement. Some models may be discontinued without notice.

Features

- 20 mm optical pitch minimizes non-detection area (BW20-□)
- Long sensing distance up to 7 m
- 22 configurations (number of optics : 4 to 48/optical pitch : 20, 40 mm /detection area : 120 to 940 mm)
- Mutual interference prevention function, self-diagnosis function, stable operation test
- Bright LED indicators on emitter and receiver
- Ambient illuminance : 100,000lux (upgraded feature)
- IP65 protection structure (IEC standard)

Safety Considerations

- Observe all 'Safety Considerations' for safe and proper operation to avoid hazards.
- ⚠ symbol indicates caution due to special circumstances in which hazards may occur.

⚠ Warning Failure to follow instructions may result in serious injury or death.

01. Fail-safe device must be installed when using the unit with machinery that may cause serious injury or substantial economic loss. (e.g. nuclear power control, medical equipment, ships, vehicles, railways, aircraft, combustion apparatus, safety equipment, crime/disaster prevention devices, etc.)

Failure to follow this instruction may result in personal injury, economic loss or fire.

02. Do not use the unit in the place where flammable/explosive/corrosive gas, high humidity, direct sunlight, radiant heat, vibration, impact, or salinity may be present.

Failure to follow this instruction may result in explosion or fire.

03. Do not connect, repair, or inspect the unit while connected to a power source.

Failure to follow this instruction may result in fire.

04. Check 'Connections' before wiring.

Failure to follow this instruction may result in fire.

05. Do not disassemble or modify the unit.

Failure to follow this instruction may result in fire.

06. This product is not safety sensor and does not observe any domestic nor international safety standard.

Do not use this product with the purpose of injury prevention or life protection, as well as in the place where economic loss maybe present.

⚠ Caution Failure to follow instructions may result in injury or product damage.

01. Use the unit within the rated specifications.

Failure to follow this instruction may result in fire or product damage.

02. Use a dry cloth to clean the unit, and do not use water or organic solvent.

Failure to follow this instruction may result in fire.

03. Do not use a load over the range of rated relay specification.

Failure to follow this instruction may result in fire, relay broken, contact melt, insulation failure or contact failure.

Cautions during Use

- Follow instructions in 'Cautions during Use'. Otherwise, It may cause unexpected accidents.
- 12 - 24 VDC \Rightarrow power supply should be insulated and limited voltage/current or Class 2, SELV power supply device.
- Use the product, 1 sec after supplying power. When using separate power supply for the sensor and load, supply power to sensor first.
- When using switching mode power supply to supply the power, ground F.G. terminal and connect a condenser between 0 V and F.G. terminal to remove noise.
- When connecting a DC relay or other inductive load, remove surge by using diodes or varistors.
- Wire as short as possible and keep away from high voltage lines or power lines, to prevent surge and inductive noise.
- This unit may be used in the following environments.
 - Indoors (in the environment condition rated in 'Specifications')
 - Altitude max. 2,000 m
 - Pollution degree 2
 - Installation category II

Cautions during Installation

- Be sure to install this product by following the usage environment, location, and specified ratings. Consider the listed conditions below.
 - Installation environment and background (reflected light)
 - Sensing distance and sensing target
 - Direction of target's movement
 - Feature data
- If the installation environment has reflected light from the wall or floor, a interval distance of at least 0.5 m is required.
- When installing multiple sensors closely, it may result in malfunction due to mutual interference. Install it by referring to the interference protection and the installation method in the manual.
- Do not use in places where the light-receiving sensor is exposed to direct sunlight or where the ambient illumination is higher than the specification.
- Do not impact with a hard object or bend the cable excessively. That could decrease the product's water resistance.
- Use this product after the test. Check whether the indicator works appropriately for the positions of the detectable object.

Ordering Information

This is only for reference, the actual product does not support all combinations. For selecting the specified model, follow the Autonics website.

BW ① - ② ③

① Optical axis pitch

Number: Optical axis pitch (unit: mm)

② Number of optical axes

Number: Number of optical axes

③ Control output

No-mark: NPN open collector output

P: PNP open collector output

Product Components

- Product × 1
- Instruction manual × 1
- Bracket A × 4
- Bracket B × 4
- Fixing bolt × 8

Sold Separately

- Connection cable: CID4-□T(R) (1 set - emitter and receiver)

Connections

Brown	12 - 24 VDC≡	White	SYNC
Blue	0 V	Black	TEST (M/S) (emitter) / OUT (receiver)

■ NPN open collector output

■ PNP open collector output

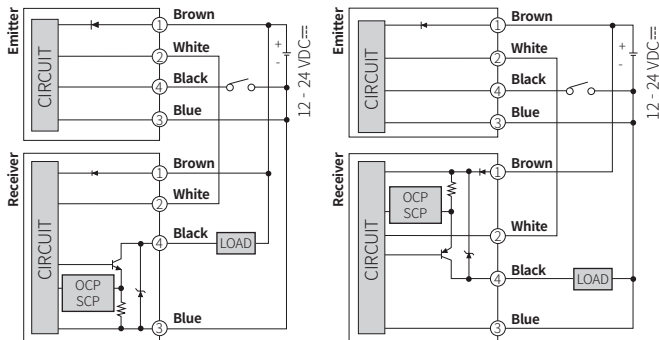

• OCP (over current protection), SCP (short circuit protection)

Operation Timing Chart

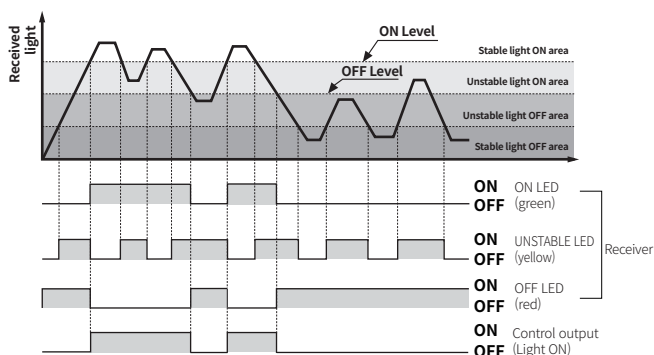

Dimensions

- Unit: mm, For the detailed drawings, follow the Autonics website.

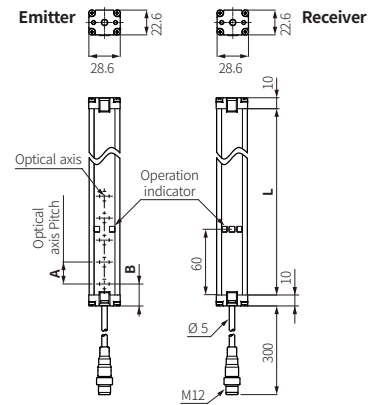

■ Optical axis Pitch (A, B) 20 mm

Model	Product length (L)	Num. of optical axes	Sensing height
BW20-08(P)	160	8	140 mm
BW20-12(P)	240	12	220 mm
BW20-16(P)	320	16	300 mm
BW20-20(P)	400	20	380 mm
BW20-24(P)	480	24	460 mm
BW20-28(P)	560	28	540 mm
BW20-32(P)	640	32	620 mm
BW20-36(P)	720	36	700 mm
BW20-40(P)	800	40	780 mm
BW20-44(P)	880	44	860 mm
BW20-48(P)	960	48	940 mm

■ Optical axis Pitch (A, B) 40 mm

Model	Product length (L)	Num. of optical axes	Sensing height
BW40-04(P)	160	4	120 mm
BW40-06(P)	240	6	200 mm
BW40-08(P)	320	8	280 mm
BW40-10(P)	400	10	360 mm
BW40-12(P)	480	12	440 mm
BW40-14(P)	560	14	520 mm
BW40-16(P)	640	16	600 mm
BW40-18(P)	720	18	680 mm
BW40-20(P)	800	20	760 mm
BW40-22(P)	880	22	840 mm
BW40-24(P)	960	24	920 mm

■ Bracket A

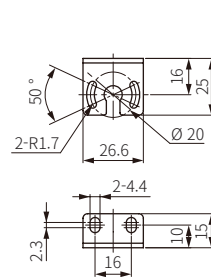

■ Bracket B

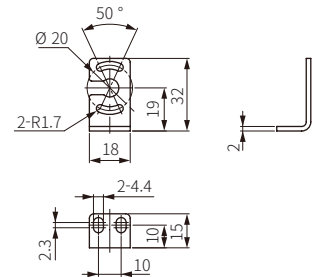

Operation Indicator

☀ ON	●	Flashing at 0.5 sec interval	▶▶ (01)	Cross-flashing at 0.5 sec interval
● OFF	○○/○○○	Flashing simultaneously at 0.5 sec interval	▶▶▶▶	Sequence flashing at 0.5 sec interval

01) Repeated twice, flashes twice at 0.5 second intervals

Item	Emitter indicator		Receiver indicator			Control output (Light ON)
	Green	Red	Green	Yellow	Red	
Power ON	☀	●	-	-	-	-
MASTER operation	☀	●	-	-	-	-
SLAVE operation	☀	☀	-	-	-	-
TEST input	☀	●	-	-	-	-
Break of emitter	▶▶	▶▶	-	-	-	-
Break of light emitting element	▶	▶	▶	▶	▶	OFF
Installation mode	Normal installation	●	●	☀	●	OFF
	Hysteresis section	●	●	☀	☀	OFF
	Abnormal installation	●	●	●	●	OFF
Stable light ON	-	-	☀	●	●	ON
Unstable light ON	-	-	☀	☀	●	ON
Unstable light OFF	-	-	●	☀	☀	OFF
Stable light OFF	-	-	●	●	☀	OFF
Break of receiver	-	-	▶▶	▶▶	▶▶	OFF
Over current	-	-	▶▶	▶▶	☀	OFF
Synchronous line noise	-	-	●	●	●	OFF
Emitter failure (Time out)	-	-	●	●	●	OFF
Optical axis misalignment alarm	-	-	▶▶	☀	▶▶	-

Specifications

Model	BW20-□(P)	BW40-□(P)
Sensing method	Through-beam	
Light source	Infrared LED (850 nm modulated light)	
Sensing distance	0.1 to 7.0 m	
Sensing target	Opaque material	
Min. sensing target	≥ Ø 30 mm	≥ Ø 50 mm
Number of optical axes	8 to 48	4 to 24
Sensing height	140 to 940 mm	120 to 920 mm
Optical axis pitch	20 mm	40 mm
Response time	≤ 10 ms	
Operation mode	Light ON	
Functions	Emitter OFF (external diagnosis), self-diagnosis	
Interference protection	Interference protection by MASTER / SLAVE function ⁰¹⁾	
Synchronization type	Timing method by synchronous line	
Indicator	Emitter: Operation indicator (green, red), receiver: Operation indicator (red, yellow, green)	
Approval	CE ENEC	CE ENEC
Weight (packaged)	≈ 1.4 kg (≈ 2.1 kg) (based on BW20-48)	≈ 1.4 kg (≈ 2.1 kg) (based on BW40-24)
01) Connect '(TEST)M/S' of SLAVE emitter to 'SYNC' of MASTER. Refer to the product manual.		
Power supply	12 - 24 VDC≒ (ripple P-P: ≤ 10 %)	
Current consumption	Emitter / receiver: ≤ 120 mA	
Control output	NPN or PNP open collector output	
Load voltage	≤ 30 VDC≒	
Load current	≤ 100 mA	
Residual voltage	NPN: ≤ 1 VDC≒, PNP: ≤ 2.5 VDC≒	
Protection circuit	Reverse power protection circuit, output short overcurrent protection circuit	
Insulation resistance	≥ 20 MΩ (500 VDC≒ megger)	
Noise immunity	± 240 V the square wave noise (pulse width 1μs) by the noise simulator	
Dielectric strength	1,000 VAC ~ 50 / 60 Hz for 1minute	
Vibration	1.5 mm double amplitude at frequency of 10 to 55 Hz (for 1 min) in each X, Y, Z direction for 2 hours	
Shock	500 m/s ² (≈ 50 G) in each X, Y, Z direction for 3 times	
Ambient illumination (receiver)	Ambient light: ≤ 100,000 lx	
Ambient temperature	-10 to 55 °C, storage: -20 to 60 °C (no freezing or condensation)	
Ambient humidity	35 to 85 %RH, storage: 35 to 85 %RH (no freezing or condensation)	
Protection rating	IP65 (IEC standard)	
Cable spec.	Ø 5 mm, 4-wire, 300 mm	
Connector spec.	M12 plug connector	
Material	Case: AL, front cover and sensing part: acryl	

Troubleshooting

Malfunction	Cause	Troubleshooting
Non-operation	Power supply	Supply the rated power.
	Cable incorrect connection, or disconnection	Check the wiring connection.
	Out of rated sensing distance	Use it within rated sensing distance.
Non-operation in sometimes	Pollution by dirt of sensor cover	Remove dirt by soft brush or cloth.
	Connector connection failure	Check the assembled part of the connector
Control output is OFF even though there is not a target object.	Out of the rated sensing distance	Use it within the rated sensing distance.
	There is an obstacle to cut off the emitted light between emitter and receiver.	Remove the obstacle.
	There is strong electric wave or noise generator such as motor, electric generator, or high voltage line, etc.	Put away the strong electric wave or noise generator.
LED displays for failure of emitter	Break of emitter	Contact Autonics Corp.
LED displays for failure of receiver	Break of receiver	
LED displays for break of light emitting element	Break of light emitting element	
LED displays for synchronous line	Synchronous line incorrect connection or disconnection	Check the wiring connection.
	Break of synchronous circuit of emitter or receiver	Contact Autonics Corp.
LED displays for emitter malfunction	Break of emitter	Treat after checking the emitter display LED.
LED displays for over current	Control output line is shorted out.	Check the wiring connection.
	Over load	Check the rated load capacity.

Functions

■ Interference protection

In case of using 2 sensors in parallel in order to extend sensing width, it may cause sensing error because as light interference. This function is operating a sensor as MASTER and another sensor as SLAVE to avoid these sensing errors by the light interference. Connect '(TEST)M/S' of SLAVE emitter to 'SYNC' of MASTER.

- Time chart for MASTER/SLAVE transmission pulse

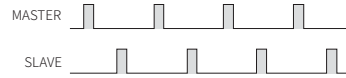

- MASTER / SLAVE connections (NPN open collector output)

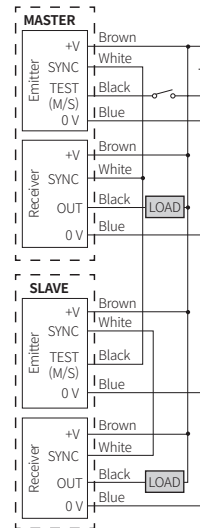

- MASTER / SLAVE connections (PNP open collector output)

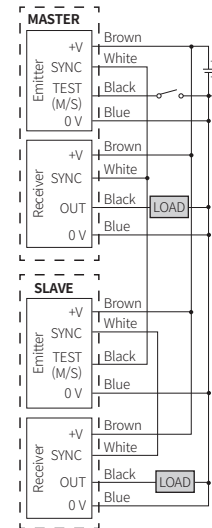

■ Emitter OFF (external diagnosis)

When 0 V is applied to the TEST input of the emitter, the light emission is forcibly stopped and the external system can check whether the sensor is operating normally. When the emission is stopped, the light is blocked. In the case of Light ON mode, the control output turns OFF. If the emitting stops, sensor is in light OFF status and control output of receiver turns OFF.

- Connections for TEST input

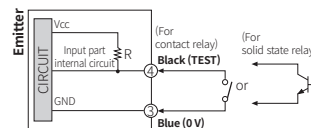

- Control output pulse by TEST input

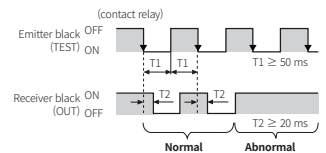

■ Optical axis misalignment alarm (low light intensity alarm)

This function outputs optical axis misalignment alarm, when front screen is contaminated with dust, optical axis is misaligned due to vibration, emitter is damaged due to the longterm usage, or light is not received due to obstacle such as leaves and trash on the product. The control output is changed according to the degree of optical axis misalignment, and the red and green operation indicators of the receiver flash alternately in 0.5 sec, and the yellow operation indicator turns on.

■ Self-Diagnosis

If there is checked malfunction during normal operation by regular self-diagnosis, control output turns OFF and operation indicator displays the state. For more information, see the "Operation Indicator"

- Break of emitter
- Break of emitter circuit
- Malfunction of MASTER / SLAVE line (operation in MASTER)
- Break of receiver
- Control output over current
- Noise of synchronous line

Installations

■ For direction of installation

Emitter and receiver should be installed in same up/down direction.

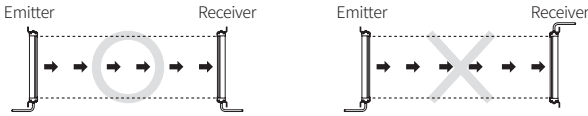

■ For reflection from the surface of wall and flat

When installing it as below, the light reflected from the surface of wall and flat is not shaded. Please check whether it operates normally or not with a sensing target before using. (interval distance: ≥ 0.5 m)

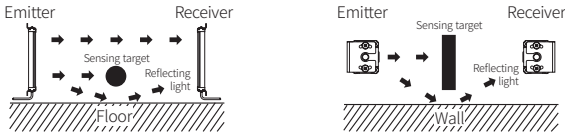

■ For protection of interference

It may cause interference when installing more than 2 sets of the sensor. In order to avoid the interference of the sensor, please install as following figures and use the transmitted light frequency changing function.

- Transmission direction should be opposite between 2 sets.

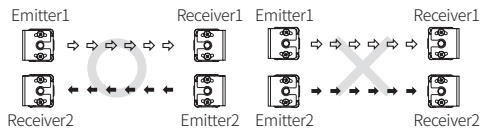
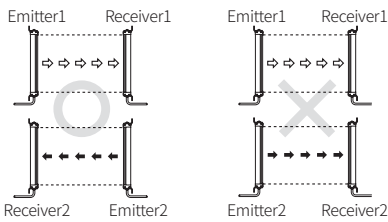
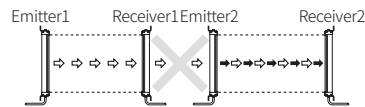
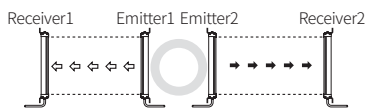

- Baffle should be installed between 2 sets.

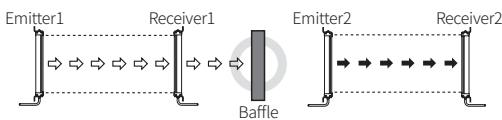

- It should be installed out of the interference distance.

: It may be a little different based on installation environment.

: Avoid using the unit in the place where the sensor is exposed directly to the fluorescent light with high speed start or high frequency.

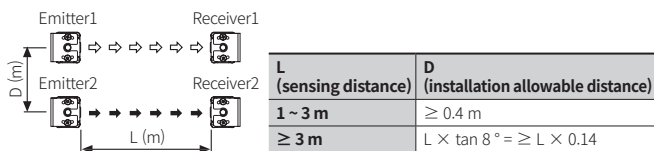

Feature Data

■ Parallel shifting characteristic

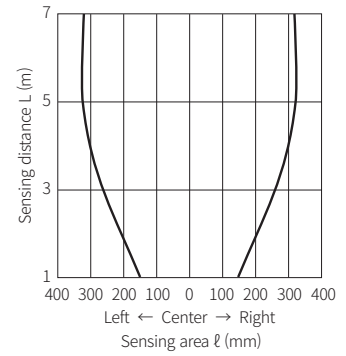
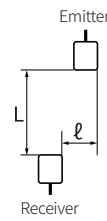

■ Angle characteristic

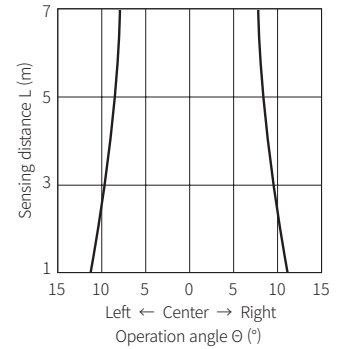
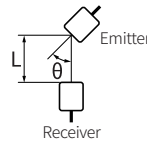

Bracket Mounting

■ Bracket A

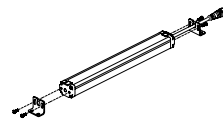

■ Bracket B

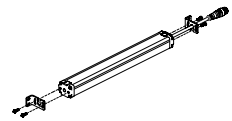

Sold Separately: Connection Cable

- Connecting cable is as one set, each of emitter's and receiver's.

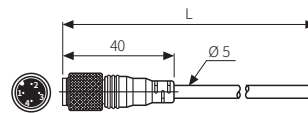

Type	Model	L	Cable color
Emitter	CID4-□T	3 / 5 / 7 / 10 / 15 m	Black
Receiver	CID4-□R	3 / 5 / 7 / 10 / 15 m	Gray