

Ø 22/25 mm Emergency Switches



S2ER Series CATALOG

For your safety, read and follow the considerations written in the instruction manual, other manuals and Autonics website.

The specifications, dimensions, etc. are subject to change without notice for product improvement. Some Models may be discontinued without notice.

Features

- Smooth operation
- High electrical conductivity
- Long-lasting durability

Safety Considerations

- Observe all 'Safety Considerations' for safe and proper operation to avoid hazards.
- ⚠ symbol indicates caution due to special circumstances in which hazards may occur.

⚠ Warning Failure to follow instructions may result in serious injury or death.

- 01. Fail-safe device must be installed when using the unit with machinery that may cause serious injury or substantial economic loss. (e.g. nuclear power control, medical equipment, ships, vehicles, railways, aircraft, combustion apparatus, safety equipment, crime / disaster prevention devices, etc.)**
Failure to follow this instruction may result in personal injury, economic loss or fire.
- 02. Do not use the unit in the place where flammable / explosive / corrosive gas, high humidity, direct sunlight, radiant heat, vibration, impact, or salinity may be present.**
Failure to follow this instruction may result in explosion or fire.
- 03. Install on a device panel to use.**
Failure to follow this instruction may result in fire or electric shock.
- 04. Do not connect, repair, or inspect the unit while connected to a power source.**
Failure to follow this instruction may result in fire or electric shock.
- 05. Do not disassemble or modify the unit.**
Failure to follow this instruction may result in fire or electric shock.

⚠ Caution Failure to follow instructions may result in injury or product damage.

- 01. This unit shall not be used outdoors.**
Failure to follow this instruction may result in shortening the life cycle of the product or electric shock.
- 02. Use the unit within the rated specifications.**
Failure to follow this instruction may result in fire or product damage.
- 03. Do not use the load beyond rated switching capacity contact.**
Failure to follow this instruction may result in fire, relay broken, contact melt, insulation failure or contact failure.
- 04. For wiring the product, do not pull the wiring excessively or apply excessive force.**
Failure to follow this instruction may result in product damage or malfunction.
- 05. Use dry cloth to clean the unit, and do not use water or organic solvent.**
Failure to follow this instruction may result in fire or electric shock.
- 06. Keep the product away from metal chip, dust, and wire residue which from flowing into the unit.**
Failure to follow this instruction may result in fire or product damage.

Specifications

Series	S2ER Series
Actuation distance	5.0 to 5.5 mm
Actuation angle	40° ± 7°
Actuation force	0.5 kgf (4.9 N) (per 1 contact)
Installation	Extended
Shock	300 m/s ² (≈ 30 G) in each X, Y, Z direction for 3 times
Shock (malfunction)	100 m/s ² (≈ 10 G) in each X, Y, Z direction for 3 times
Vibration	1.5 mm double amplitude at frequency of 10 to 55 Hz in each X, Y, Z direction for 2 hours
Vibration (malfunction)	1.5 mm double amplitude at frequency of 10 to 55 Hz in each X, Y, Z direction for 10 minutes
Mechanical life cycle (control unit life cycle)	≥ 100,000 operations (20 operations/min)
Ambient temperature	-15 to 55 °C, storage: -25 to 65 °C (no freezing or condensation)
Ambient humidity	35 to 85 %RH, storage: 35 to 85 %RH (no freezing or condensation)
Protection structure	Control unit: IP52 (IEC standard)
Certification	CE UK ENEC ETL cTUVus ENEC PS
Control unit weight	D30: ≈ 22.5 g D40: ≈ 22.5 g D60: ≈ 27 g
Housing weight	≈ 7 g

Contact blocks

Power supply / current	110 VAC~ / 10 A, 250 VAC~ / 6 A
Dielectric strength	Between the charging part and the case : 3,000 VAC~ 50/60 Hz for 1 minute
Insulation resistance	≥ 1,000 MΩ (500 VDC== megger)
Contact resistance	≤ 20 mΩ (initial)
Electrical life cycle	≥ 100,000 operations (20 operations/min)
Contact material	AgNi10
Certification	CE UK ENEC ETL cTUVus ENEC PS
Weight	Modular type: ≈ 10 g, Singular type: ≈ 11 g

LED blocks

Rated voltage	AC/DC voltage type: 12-24 VAC~ 50/60 Hz, 12-24 VDC== AC voltage type: 110-220 VAC~ 50/60 Hz
Current consumption	≤ 20 mA
Certification	CE UK ENEC ETL cTUVus ENEC
Weight	AC/DC voltage type: ≈ 11 g, AC voltage type: ≈ 12 g

Sold Separately

- Contact blocks (SA□-C□□)
- LED blocks (SA□-L□□□)
- Switch enclosures (SA-□B□)
- Locking handle (SA□-LH)
- Switch washer (SA-SW□)
- Emergency switch nameplates (SA-N□)
- Emergency switch protective shrouds (SA-EG□)

Assembly / Disassembly

- Assembly order: ①→②→③→④
- Disassembly order: a→b→c→④

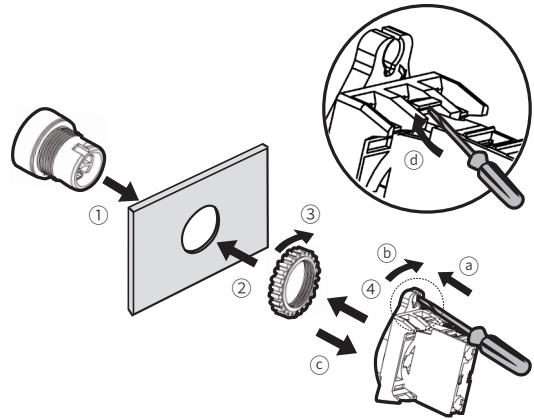

Control Switches	Panel thickness	Tightening torque
Ø 22/25/30 mm	Max. 6 mm	≤ 1.96 N·m

Ordering Information

This is only for reference. For selecting the specified Model, follow the Autonics website.

Model is based on control unit+block combination. Control units or blocks are sold separately. In case of block, refer to control switch accessories.

S2	1	-	2	3	4	5	6	7
Control unit						Block		

1 Switch type

ER: Round emergency switch (extended)

2 Operation

E: Push-lock, Turn-reset

3 Appearance

1: (non-illuminated) D30 + Long head

2: (non-illuminated) D30 + Short head

3: (non-illuminated) D40 + Short head

4: (illuminated) D40 + Short head

5: (non-illuminated) D60 + Short head

4 Color

R: Red

5 Contact block

A: 1 A contact

2A: 2 A contacts

3A: 3 A contacts

B: 1 B contact

2B: 2 B contacts

3B: 3 B contacts

AB: 1 A contact, 1 B contact

2AB: 2 A contacts, 1 B contact

A2B: 1 A contact, 2 B contacts

6 LED block (D40)

D: 1 AC/DC voltage type

L: 1 AC voltage type

7 Block type

No mark: Singular type

M: Modular type

Model	Contact block		LED block	
	A contact	B contact	AC/DC voltage	AC voltage
S2ER-E1RA(M)	1	-		
S2ER-E1R2A(M)	2	-		
S2ER-E1R3A(M)	3	-		
S2ER-E1RB(M)	-	1		
S2ER-E1R2B(M)	-	2		
S2ER-E1R3B(M)	-	3		
S2ER-E1RAB(M)	1	1		
S2ER-E1R2AB(M)	2	1		
S2ER-E1RA2B(M)	1	2		
S2ER-E2RA(M)	1	-		
S2ER-E2R2A(M)	2	-		
S2ER-E2R3A(M)	3	-		
S2ER-E2RB(M)	-	1		
S2ER-E2R2B(M)	-	2		
S2ER-E2R3B(M)	-	3		
S2ER-E2RAB(M)	1	1		
S2ER-E2R2AB(M)	2	1		
S2ER-E2RA2B(M)	1	2		
S2ER-E3RA(M)	1	-		
S2ER-E3R2A(M)	2	-		
S2ER-E3R3A(M)	3	-		
S2ER-E3RB(M)	-	1		
S2ER-E3RB-EL ⁰¹⁾	-	1		
S2ER-E3R2B(M)	-	2		
S2ER-E3R3B(M)	-	3		
S2ER-E3RAB(M)	1	1		
S2ER-E3R2AB(M)	2	1		
S2ER-E3RA2B(M)	1	2		
S2ER-E4RAD(M)	1	-		
S2ER-E4R2AD(M)	2	-	1	
S2ER-E4RBD(M)	-	1		
S2ER-E4R2BD(M)	-	2		
S2ER-E4RABL(M)	1	1		1
S2ER-E5RA(M)	1	-		
S2ER-E5R2A(M)	2	-		
S2ER-E5R3A(M)	3	-		
S2ER-E5RB(M)	-	1		
S2ER-E5R2B(M)	-	2		
S2ER-E5R3B(M)	-	3		
S2ER-E5RAB(M)	1	1		
S2ER-E5R2AB(M)	2	1		
S2ER-E5RA2B(M)	1	2		

01) Acquired KC (HU02054-20014)

Dimensions

- Unit: mm, For the detailed drawings, follow the Autonics website.
- Panel thickness: ≤ 6 mm

■ S2ER-E1R □ (D30 + long head, singular type block)

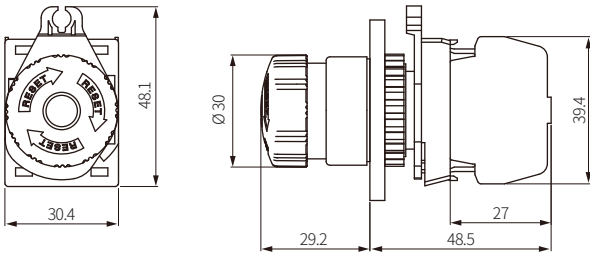

■ S2ER-E1R □ M (D30 + long head, modular type block)

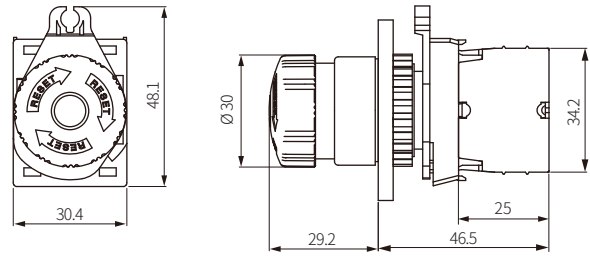

■ S2ER-E2R □ (D30 + short head, singular type block)

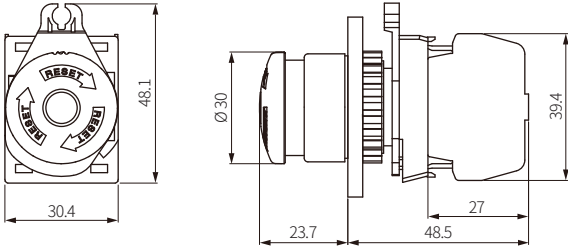

■ S2ER-E2R □ M (D30 + short head, modular type block)

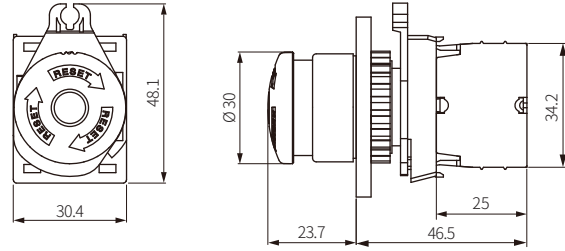

■ S2ER-E3R □ (D40 + short head, singular type block)

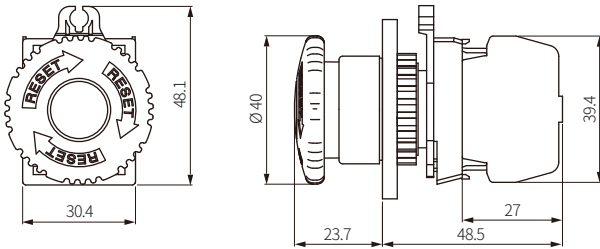

■ S2ER-E3R □ M (D40 + short head, modular type block)

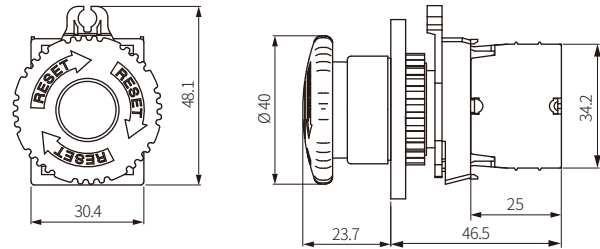

■ S2ER-E4R □ (D40 + short head, singular type block)

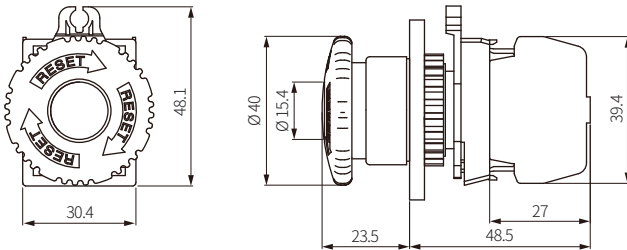

■ S2ER-E4R □ M (D40 + short head, modular type block)

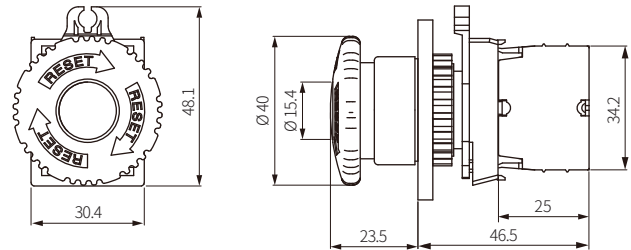

■ S2ER-E5R □ (D60 + short head, singular type block)

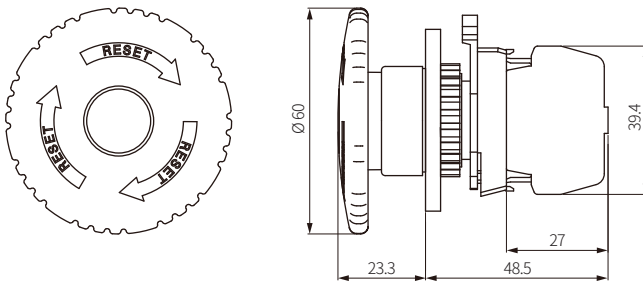

■ S2ER-E5R □ M (D60 + short head, modular type block)

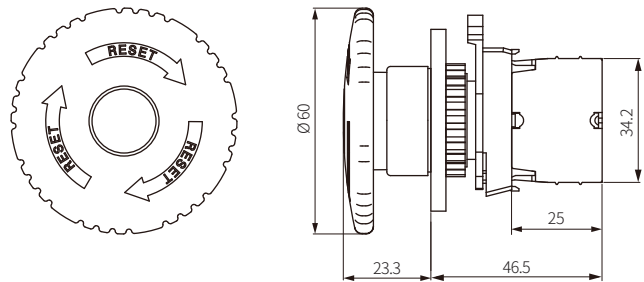

■ Panel cut-out

<Mounting round: Ø 25>

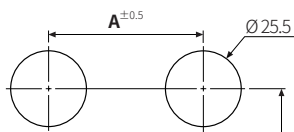

<Mounting round: Ø 22>

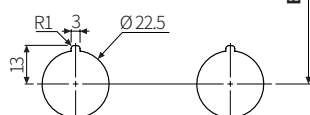

	A	B
D30	≥ 33	≥ 55
D40	≥ 55	≥ 55
D60	≥ 80	≥ 80