

Ø 30 mm Push Button Switches



S3PR / S3PF Series CATALOG

For your safety, read and follow the considerations written in the instruction manual, other manuals and Autonics website.

The specifications, dimensions, etc. are subject to change without notice for product improvement. Some models may be discontinued without notice.

Features

- Smooth operation
- High electrical conductivity
- Long-lasting durability

Safety Considerations

- Observe all 'Safety Considerations' for safe and proper operation to avoid hazards.
- ⚠ symbol indicates caution due to special circumstances in which hazards may occur.

⚠ Warning Failure to follow instructions may result in serious injury or death.

- 01. Fail-safe device must be installed when using the unit with machinery that may cause serious injury or substantial economic loss. (e.g. nuclear power control, medical equipment, ships, vehicles, railways, aircraft, combustion apparatus, safety equipment, crime / disaster prevention devices, etc.)**
Failure to follow this instruction may result in personal injury, economic loss or fire.
- 02. Do not use the unit in the place where flammable / explosive / corrosive gas, high humidity, direct sunlight, radiant heat, vibration, impact, or salinity may be present.**
Failure to follow this instruction may result in explosion or fire.
- 03. Install on a device panel to use.**
Failure to follow this instruction may result in fire or electric shock.
- 04. Do not connect, repair, or inspect the unit while connected to a power source.**
Failure to follow this instruction may result in fire or electric shock.
- 05. Do not disassemble or modify the unit.**
Failure to follow this instruction may result in fire or electric shock.

⚠ Caution Failure to follow instructions may result in injury or product damage.

- 01. This unit shall not be used outdoors.**
Failure to follow this instruction may result in shortening the life cycle of the product or electric shock.
- 02. Use the unit within the rated specifications.**
Failure to follow this instruction may result in fire or product damage.
- 03. Do not use the load beyond rated switching capacity contact.**
Failure to follow this instruction may result in fire, relay broken, contact melt, insulation failure or contact failure.
- 04. For wiring the product, do not pull the wiring excessively or apply excessive force.**
Failure to follow this instruction may result in product damage or malfunction.
- 05. Use dry cloth to clean the unit, and do not use water or organic solvent.**
Failure to follow this instruction may result in fire or electric shock.
- 06. Keep the product away from metal chip, dust, and wire residue which from flowing into the unit.**
Failure to follow this instruction may result in fire or product damage.

Specifications

Series	S3PR Series	S3PF Series
Actuation distance	5.0 to 5.5 mm	
Actuation force	0.5 kgf (4.9 N) (per 1 contact)	
Installation	Extended	Flush
Shock	300 m/s ² (≈ 30 G) in each X, Y, Z direction for 3 times	
Shock (malfunction)	100 m/s ² (≈ 10 G) in each X, Y, Z direction for 3 times	
Vibration	1.5 mm double amplitude at frequency of 10 to 55 Hz in each X, Y, Z direction for 2 hours	
Vibration (malfunction)	1.5 mm double amplitude at frequency of 10 to 55 Hz in each X, Y, Z direction for 10 minutes	
Mechanical life cycle (control unit life cycle)	Returned: ≥ 1 million operations (20 operations/min)	
Ambient temperature	-15 to 55 °C, storage: -25 to 65 °C (no freezing or condensation)	
Ambient humidity	35 to 85 %RH, storage: 35 to 85 %RH (no freezing or condensation)	
Protection structure	Control unit: IP52 (IEC standard)	
Certification		
Control unit weight	21.5 g	
Housing weight	≈ 7 g	

Contact blocks	
Power supply / current	110 VAC~ / 10 A, 250 VAC~ / 6 A
Dielectric strength	Between the charging part and the case : 3,000 VAC~ 50/60 Hz for 1 minute
Insulation resistance	≥ 1,000 MΩ (500 VDC== megger)
Contact resistance	≤ 20 mΩ (initial)
Electrical life cycle	≥ 100,000 operations (20 operations/min)
Contact material	AgNi10
Certification	
Weight	Modular type: ≈ 10 g, Singular type: ≈ 11 g
LED blocks	
Rated voltage	AC/DC voltage type: 12-24 VAC~ 50/60 Hz, 12-24 VDC== AC voltage type: 110-220 VAC~ 50/60 Hz
Current consumption	≤ 20 mA
Certification	
Weight	AC/DC voltage type: ≈ 11 g, AC voltage type: ≈ 12 g

Sold Separately

- Contact blocks (SA□-C□□)
- LED blocks (SA□-L□□□)
- Locking handle (SA□-LH)
- Switch washer (SA-SW□)

Assembly / Disassembly

- Assembly order: ①→②→③→④
- Disassembly order: ④→③→②→①

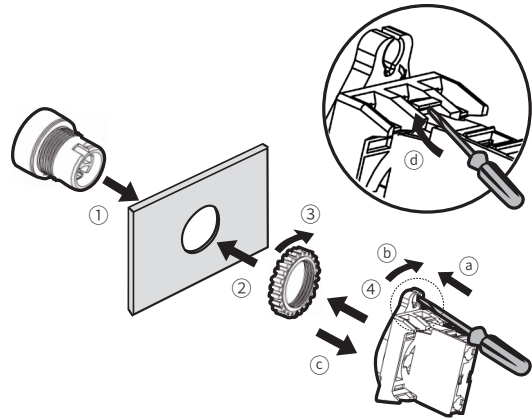

Control Switches	Panel thickness	Tightening torque
Ø 22/25/30 mm	Max. 6 mm	≤ 1.47 N·m

Ordering Information

This is only for reference. For selecting the specified model, follow the Autonics website.

Model is based on control unit+block combination. Control units or blocks are sold separately. In case of block, refer to control switch accessories.

■ Non-illuminated

S3	1	-	2	3	4	5
Control unit					Block	

1 Switch type

PR: Round push button switch (extended)

PF: Round push button switch (flush)

2 Illuminated

P1: Non-illuminated

3 Color

R: Red

B: Blue

G: Green

Y: Yellow

K: Black

4 Contact block

A: 1 A contact

2A: 2 A contacts

3A: 3 A contacts

B: 1 B contact

2B: 2 B contacts

3B: 3 B contacts

AB: 1 A contact, 1 B contact

2AB: 2 A contacts, 1 B contact

A2B: 1 A contact, 2 B contacts

5 Block type

No mark: Singular type

M: Modular type

Model	Contact block		LED block	
	A contact	B contact	AC/DC voltage	AC voltage
S3PR-P1□A(M)	1	-	-	-
S3PR-P1□2A(M)	2	-		
S3PR-P1□3A(M)	3	-		
S3PR-P1□B(M)	-	1		
S3PR-P1□2B(M)	-	2		
S3PR-P1□3B(M)	-	3		
S3PR-P1□AB(M)	1	1		
S3PR-P1□2AB(M)	2	1		
S3PR-P1□A2B(M)	1	2		
S3PF-P1□A(M)	1	-		
S3PF-P1□2A(M)	2	-	-	-
S3PF-P1□3A(M)	3	-		
S3PF-P1□B(M)	-	1		
S3PF-P1□2B(M)	-	2		
S3PF-P1□3B(M)	-	3		
S3PF-P1□AB(M)	1	1		
S3PF-P1□2AB(M)	2	1		
S3PF-P1□A2B(M)	1	2		

■ Illuminated

S3	1	2	-	3	4	5	6	7
Control unit						Block		

1 Switch type

PF: Round push button switch (flush)

2 Character marking

No mark: Push (control unit + singular type block)

No mark: None (control unit + modular type block)

U: None (control unit) ⁰¹⁾

2 Illuminated

P3: Illuminated

4 Color

R: Red

B: Blue

G: Green

Y: Yellow

W: White

3 Contact block

A: 1 A contact

2A: 2 A contacts

B: 1 B contact

2B: 2 B contacts

AB: 1 A contact, 1 B contact

5 LED block

D: 1 AC/DC voltage type

L: 1 AC voltage type

7 Block type

No mark: Singular type

M: Modular type

Model	Contact block		LED block	
	A contact	B contact	AC/DC voltage	AC voltage
S3PF-P3□AD(M)	1	-	1	-
S3PF-P3□2AD(M)	2	-		
S3PF-P3□BD(M)	-	1		
S3PF-P3□2BD(M)	-	2		
S3PF-P3□ABD(M)	1	1		
S3PF-P3□AL(M)	1	-	-	1
S3PF-P3□2AL(M)	2	-		
S3PF-P3□BL(M)	-	1		
S3PF-P3□2BL(M)	-	2		
S3PF-P3□ABL(M)	1	1		

01) Only available for control unit. Select the block separately.

Dimensions

- Unit: mm, For the detailed drawings, follow the Autonics website.
- Panel thickness: ≤ 6 mm

■ S3PR-P1 □ (non-illuminated, extended, singular type block)

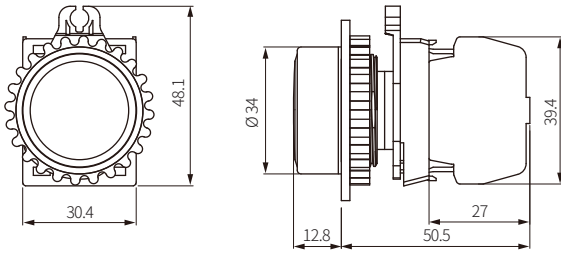

■ S3PR-P1 □ M (non-illuminated, extended, modular type block)

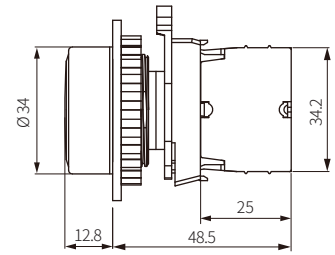

■ S3PF-P1 □ (non-illuminated, flush, singular type block)

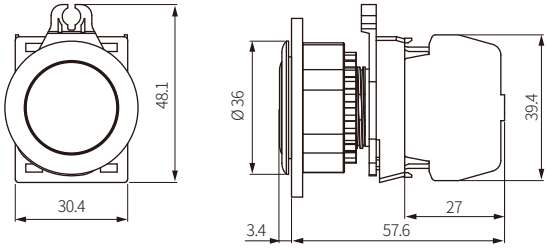

■ S3PF-P1 □ M (non-illuminated, flush, modular type block)

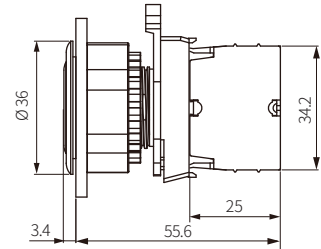

■ S3PF-P3 □ (illuminated, flush, singular type block)

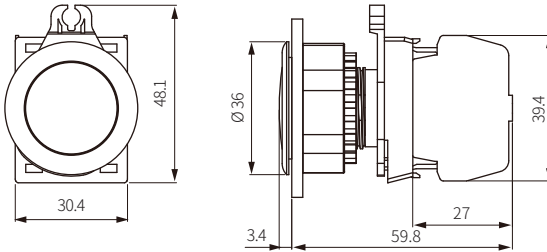

■ S3PF-P3 □ M (illuminated, flush, modular type block)

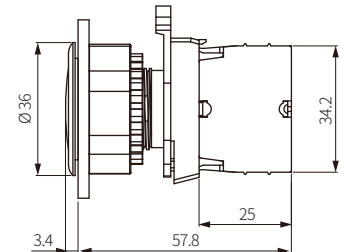

■ Panel cut-out

