

# Ø 16 mm Push Button Switches



## S16PR Series CATALOGPRODUCT MANUAL

For your safety, read and follow the considerations written in the instruction manual, other manuals and Autonics website.

The specifications, dimensions, etc. are subject to change without notice for product improvement. Some models may be discontinued without notice.

### Features

- Compact, space-saving 16 mm installation diameter
- Short rear-length size of only 29.5 mm
- Independent detachable contacts

### Safety Considerations

- Observe all 'Safety Considerations' for safe and proper operation to avoid hazards.
- ⚠ symbol indicates caution due to special circumstances in which hazards may occur.







**⚠ Warning** Failure to follow instructions may result in serious injury or death.

- 01. Fail-safe device must be installed when using the unit with machinery that may cause serious injury or substantial economic loss. (e.g. nuclear power control, medical equipment, ships, vehicles, railways, aircraft, combustion apparatus, safety equipment, crime / disaster prevention devices, etc.)**  
Failure to follow this instruction may result in personal injury, economic loss or fire.
- 02. Do not use the unit in the place where flammable / explosive / corrosive gas, high humidity, direct sunlight, radiant heat, vibration, impact, or salinity may be present.**  
Failure to follow this instruction may result in explosion or fire.
- 03. Install on a device panel to use.**  
Failure to follow this instruction may result in fire or electric shock.
- 04. Do not connect, repair, or inspect the unit while connected to a power source.**  
Failure to follow this instruction may result in fire or electric shock.
- 05. Do not disassemble or modify the unit.**  
Failure to follow this instruction may result in fire or electric shock.













**⚠ Caution** Failure to follow instructions may result in injury or product damage.

- 01. This unit shall not be used outdoors.**  
Failure to follow this instruction may result in shortening the life cycle of the product or electric shock.
- 02. Use the unit within the rated specifications.**  
Failure to follow this instruction may result in fire or product damage.
- 03. Do not use the load beyond rated switching capacity contact.**  
Failure to follow this instruction may result in fire, relay broken, contact melt, insulation failure or contact failure.
- 04. For wiring the product, do not pull the wiring excessively or apply excessive force.**  
Failure to follow this instruction may result in product damage or malfunction.
- 05. Use dry cloth to clean the unit, and do not use water or organic solvent.**  
Failure to follow this instruction may result in fire or electric shock.
- 06. Keep the product away from metal chip, dust, and wire residue which from flowing into the unit.**  
Failure to follow this instruction may result in fire or product damage.

## Specifications

<b>Series</b>	<b>S16PR Series</b>
<b>Actuation distance</b>	3 mm
<b>Actuation force</b>	0.2 to 0.35 kgf (2 to 3.5 N)
<b>Installation</b>	Extended
<b>Shock</b>	500 m/s <sup>2</sup> (≈ 30 G) in each X, Y, Z direction for 3 times
<b>Shock (malfunction)</b>	100 m/s <sup>2</sup> (≈ 10 G) in each X, Y, Z direction for 3 times
<b>Vibration</b>	1.5 mm double amplitude at frequency of 10 to 55 Hz in each X, Y, Z direction for 2 hours
<b>Vibration (malfunction)</b>	1.5 mm double amplitude at frequency of 10 to 55 Hz in each X, Y, Z direction for 10 minutes
<b>Mechanical life cycle (control unit life cycle)</b>	Returned: ≥ 1 million operations (20 operations/min) Maintained: ≥ 200,000 operations (20 operations/min)
<b>Ambient temperature</b>	-15 to 55 °C, storage: -25 to 65 °C (no freezing or condensation)
<b>Ambient humidity</b>	35 to 85 %RH, storage: 35 to 85 %RH (no freezing or condensation)
<b>Protection structure</b>	Control unit: IP65 (IEC standard)
<b>Certification</b>	CE <sup>01</sup> UK       
<b>Control unit weight</b>	Round: ≈ 3.8 g, Square: ≈ 4.4 g, Rectangular: ≈ 5.1 g
<b>Housing weight</b>	≈ 1.4 g

01) IEC-60947-5-1

<b>Contact blocks</b>	
Power supply/current	250 VAC~ / 3 A
Dielectric strength	Between the charging part and the case : 3,000 VAC~ 50/60 Hz for 1 minute
Insulation resistance	≥ 100 MΩ (500 VDC= megger)
Contact resistance	≤ 50 mΩ (initial)
Electrical life cycle	≥ 100,000 operations (20 operations/min)
Contact material	AgNi10
Terminal tensile force	≤ 30 N
Terminal soldering time	At the end of tips within 3 sec with 350 °C (30 W-soldering machine)
Certification	CE      
Weight	≈ 1.6 g
<b>LED blocks</b>	
Rated voltage	5 / 12 / 24 VDC= model
Current consumption	Refer to the below Current consumption table.
Certification	CE      
Weight	≈ 1.9 g

Current consumptions	Red	Blue	Green	Yellow	White
<b>SA16-L5□ (5 VDC=)</b>	6 to 9 mA	10 to 14 mA	5 to 7 mA	12 to 16 mA	10 to 14 mA
<b>SA16-L12□ (12 VDC=)</b>	9 to 14 mA	10 to 15 mA	5 to 9 mA	10 to 16 mA	9 to 14 mA
<b>SA16-L24□ (24 VDC=)</b>	15 to 20 mA	20 to 26 mA	16 to 22 mA	27 to 35 mA	23 to 30 mA

## Sold Separately

- Contact blocks (SA□-C□□)
- LED blocks (SA□-L□□□)
- Locking handle (SA□-LH)

## Assembly / Disassembly

- Assembly order: ①→②→③→④
- Disassembly order: a→b→c→④

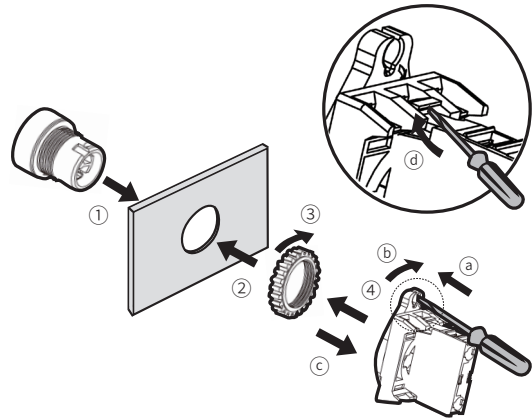

Control Switches	Panel thickness	Tightening torque
Ø 16 mm	Max. 3.5 mm	≤ 0.49 N·m

## Ordering Information

This is only for reference. For selecting the specified model, follow the Autonics website.

Model is based on control unit+block combination. Control units or blocks are sold separately. In case of block, refer to control switch accessories.

### ■ Non-illuminated

<b>S16</b>	<b>1</b>	<b>2</b>	-	<b>3</b>	<b>4</b>	<b>5</b>	<b>6</b>
Control unit							Block

#### 1 Switch type

PR: Push button switch (extended)

#### 2 Appearance

No mark: Round  
S: Square  
T: Rectangular

#### 3 Guard

E: None  
H: Half guard

#### 4 Operation

1: Returned  
2: Maintained

#### 5 Color

R: Red  
B: Blue  
G: Green  
Y: Yellow  
W: White

#### 6 Contact block

C: 1 C contact  
2C: 2 C contacts  
3C: 3 C contacts

### ■ Illuminated

<b>S16</b>	<b>1</b>	<b>2</b>	-	<b>3</b>	<b>4</b>	<b>5</b>	<b>6</b>	<b>7</b>
Control unit							Block	

#### 1 Switch type

PR: Push button switch (extended)

#### 2 Appearance

No mark: Round  
S: Square  
T: Rectangular

#### 3 Guard

E: None  
H: Half guard

#### 4 Operation

3: Returned  
4: Maintained

#### 4 Color

R: Red  
B: Blue  
G: Green  
Y: Yellow  
W: White

#### 6 Contact block

C: 1 C contact  
2C: 2 C contacts

#### 7 LED block

5: 5 VDC=  
12: 12 VDC=  
24: 24 VDC=

Model	Contact block		LED block
	C contact		DC voltage
S16PR-E1□C	1		
S16PR-E1□2C	2		-
S16PR-E1□3C	3		
S16PR-E2□C	1		
S16PR-E2□2C	2		-
S16PR-E2□3C	3		
S16PRS-H1□C	1		
S16PRS-H1□2C	2		-
S16PRS-H1□3C	3		
S16PRS-H2□C	1		
S16PRS-H2□2C	2		-
S16PRS-H2□3C	3		
S16PRT-H1□C	1		
S16PRT-H1□2C	2		-
S16PRT-H1□3C	3		
S16PRT-H2□C	1		
S16PRT-H2□2C	2		-
S16PRT-H2□3C	3		

Model	Contact block		LED block
	C contact		DC voltage
S16PR-E3□C5			1 (5 VDC=)
S16PR-E3□C12	1		1 (12 VDC=)
S16PR-E3□C24			1 (24 VDC=)
S16PR-E3□2C5			1 (5 VDC=)
S16PR-E3□2C12	2		1 (12 VDC=)
S16PR-E3□2C24			1 (24 VDC=)
S16PR-E4□C5			1 (5 VDC=)
S16PR-E4□C12	1		1 (12 VDC=)
S16PR-E4□C24			1 (24 VDC=)
S16PR-E4□2C5			1 (5 VDC=)
S16PR-E4□2C12	2		1 (12 VDC=)
S16PR-E4□2C24			1 (24 VDC=)
S16PRS-H3□C5			1 (5 VDC=)
S16PRS-H3□C12	1		1 (12 VDC=)
S16PRS-H3□C24			1 (24 VDC=)
S16PRS-H3□2C5			1 (5 VDC=)
S16PRS-H3□2C12	2		1 (12 VDC=)
S16PRS-H3□2C24			1 (24 VDC=)
S16PRS-H4□C5			1 (5 VDC=)
S16PRS-H4□C12	1		1 (12 VDC=)
S16PRS-H4□C24			1 (24 VDC=)
S16PRS-H4□2C5			1 (5 VDC=)
S16PRS-H4□2C12	2		1 (12 VDC=)
S16PRS-H4□2C24			1 (24 VDC=)
S16PRT-H3□C5			1 (5 VDC=)
S16PRT-H3□C12	1		1 (12 VDC=)
S16PRT-H3□C24			1 (24 VDC=)
S16PRT-H3□2C5			1 (5 VDC=)
S16PRT-H3□2C12	2		1 (12 VDC=)
S16PRT-H3□2C24			1 (24 VDC=)
S16PRT-H4□C5			1 (5 VDC=)
S16PRT-H4□C12	1		1 (12 VDC=)
S16PRT-H4□C24			1 (24 VDC=)
S16PRT-H4□2C5			1 (5 VDC=)
S16PRT-H4□2C12	2		1 (12 VDC=)
S16PRT-H4□2C24			1 (24 VDC=)

## Dimensions

- Unit: mm, For the detailed drawings, follow the Autonics website.
- Panel thickness:  $\leq 3.5$  mm

### ■ S16PR-E (extended, round)

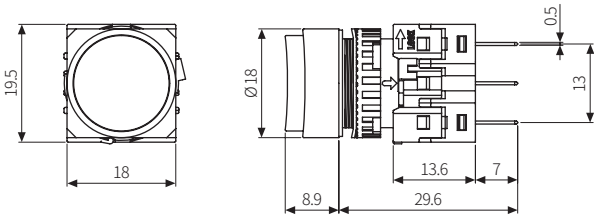

### ■ S16PRS-H (square, half guard)

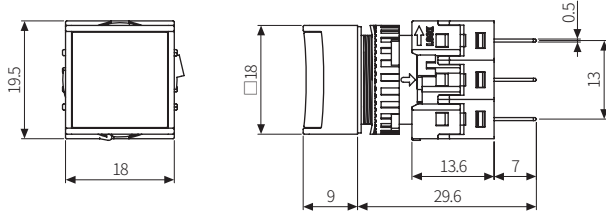

### ■ S16PRT-H (rectangular, half guard)

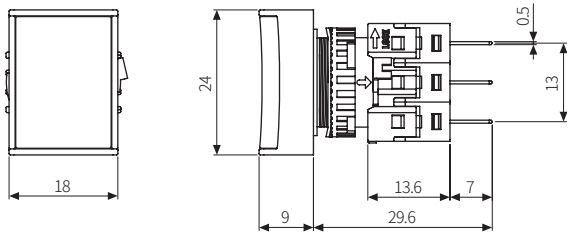

### ■ Terminal pin

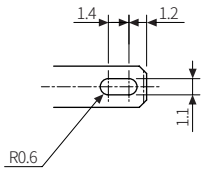

### ■ Panel cut-out

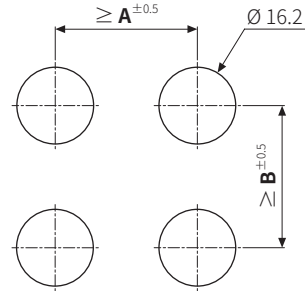

	A	B
Round	20	21
Square	20	21
Rectangular	25	21