

MT4N Series

DIN W48×H24mm Small Size Digital Multi Panel Meter

■ Features

- Various input/output options (by model)
 - Input options: DC voltage, DC current, AC voltage, AC current
 - Output options: RS485 communication output, PV transmission output (DC 4-20 mA), NPN/PNP open collector output, relay contact output
 ※default option: indicator/no output
- Maximum allowed input: 50 VDC, DC 500 mA, 250 VAC, AC 5 A
- Display range: -1999 to 9999
- High/low-limit display scale function
- AC frequency measurement (range: 0.1 to 9999 Hz)
- Various functions: peak display value monitoring, display cycle delay, zero-point adjustment, peak display value correction, PV transmission output (DC 4-20 mA) scale
- Power supply: 12-24 VDC/VAC, 100-240 VAC



⚠ Please read "Safety Considerations" in operation manual before using.



■ Ordering Information

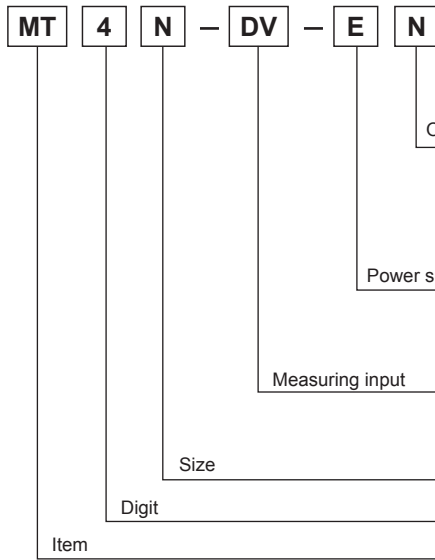

N	Indicator (without output function)
0	Relay (OUT1/OUT2) output
1	NPN open collector output (OUT1, GO, OUT2)
2	PNP open collector output (OUT1, GO, OUT2)
3	Relay (OUT1)+transmission (DC4-20mA) output
4	Relay (OUT1)+RS485 communication output
5	Relay (OUT1/OUT2)+transmission (DC4-20mA) output
E	12-24VDC/AC
4	100-240AC
DV	DC voltage
DA	DC current
AV	AC voltage
AA	AC current
N	DIN W48×H24mm
4	9999 (4-digit)
MT	Multi Meter

※To measure the current over DC5A, please select DV type because the shunt should be used.

※In case of selecting frequency display, no output will be provided even if it is output support models. (main output, sub output and RS485 communication output)

■ Unit Description

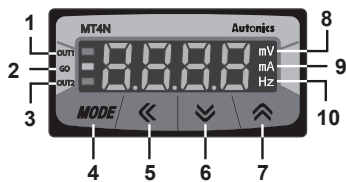

1. **OUT1**: Preset output of OUT1
2. **GO**: Preset Go output of OUT1/OUT2
3. **OUT2**: Preset output of OUT2
4. **MODE** key: Mode key
5. **←** key: Shift key
6. **↓** key: Down key
7. **↑** key: Up key
8. **mV, V unit**
9. **mA, A unit**
10. **Hz unit**

※There is no 1, 2, 3 on a display panel of MT4N-□-□N.

※MT4N-□-□3, □4 model has output display part of OUT1 only.

Specifications

Series	MT4N-DV-E□ MT4N-DA-E□	MT4N-AV-E□ MT4N-AA-E□	MT4N-DV-4□ MT4N-DA-4□	MT4N-AV-4□ MT4N-AA-4□
Measurement input	DC voltage, current		AC voltage, current, frequency	
Power supply	12-24VDC≡, 12-24VAC~		100-240VAC~	
Allowable voltage range	90 to 110%			
Power consumption	DC: 3W, AC: 5VA For MT4N-□-E5 - DC: 5W, AC: 8VA		5VA	
Display method	7-segment LCD display (character height: 9mm)			
Display accuracy	• 23°C±5°C - DC type: F.S. ±0.1% rdg ±2-digit / AC type: F.S. ±0.3% rdg ±3-digit DC/AC type: F.S. +0.3% rdg ±3-digit max. only for 5A terminal. • -10°C to 50°C - DC/AC type: F.S. ±0.5% rdg ±3-digit			
Max. allowable input	110% F.S. for each measured input range			
A/D conversion method	Practical oversampling using successive approximation ADC			
Sampling cycle	DC type: 50ms, AC type: 16.6ms			
Max. display range	-1999 to 9999 (4-digit)			
Preset output	• Relay output - Contact capacity: 125VAC~ 0.3A, 30VDC≡ 1A/Contact composition: N.O (1a) • NPN/PNP Open Collector output - Max. 12-24VDC≡ ±2V 50mA (resistive load)			
Sub output (transmission output)	• RS485 communication output - Baud rate: 1,200/2,400/4,800/9,600, Communication method : 2-wire half duplex, Synchronous method: Sub-synchronization, Protocol: Modbus type • DC4-20mA output - Resolution: 12,000 division (load resistance max. 600Ω)			
AC measuring function※1	Selectable RMS or AVG			
Frequency measuring function※1	Measurement range: 0.100 to 9999Hz (variable by decimal point position)			
Hold function※2	Includes (external hold function)			
Insulation resistance	Over 20MΩ (at 500VDC megger)			
Dielectric strength	1000VAC for 1 min (between external terminal and case)		2000VAC for 1 min (between external terminal and case)	
Noise immunity	±2kV the square wave noise (pulse width: 1μs) by the noise simulator			
Vibration	Mechanical	0.75mm amplitude at frequency of 10 to 55Hz (for 1 min) in each X, Y, Z direction for 2 hours		
	Malfunction	0.5mm amplitude at frequency of 10 to 55Hz (for 1 min) in each X, Y, Z direction for 10 min		
Shock	Mechanical	100m/s ² (approx. 10G) in each X, Y, Z direction for 3 times		
	Malfunction	300m/s ² (approx. 30G) in each X, Y, Z direction for 3 times		
Environment	Ambient temperature	-10 to 50°C, storage: -20 to 60°C		
	Ambient humidity	35 to 85%RH, storage: 35 to 85%RH		
Insulation type	Double insulation or reinforced insulation (mark: □, dielectric strength between the measuring input part and the power part: 1kV)			
Approval	CE		—	
Weight※3	Approx. 127g (approx. 64g)			

※1: AC measuring function, and frequency measuring function are only for AC measuring input type.

※2: The indicator has no Hold function.

※3: The weight includes packaging. The weight in parenthesis is for unit only.

※Environment resistance is rated at no freezing or condensation.

Dimensions

● MT4N-□-□N

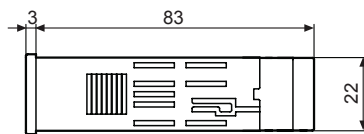
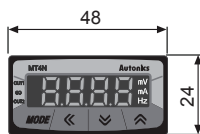

● MT4N-□-□0



● MT4N-□-□1, □2



● MT4N-□-□3, □4



● Panel cut-out

(unit: mm)

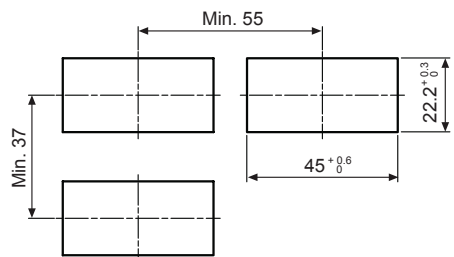

(A) Photoelectric Sensors

(B) Fiber Optic Sensors

(C) Door/Area Sensors

(D) Proximity Sensors

(E) Pressure Sensors

(F) Rotary Encoders

(G) Connectors/ Connector Cables/ Sensor Distribution Boxes/ Sockets

(H) Temperature Controllers

(I) SSRs / Power Controllers

(J) Counters

(K) Timers

(L) Panel Meters

(M) Tacho / Speed / Pulse Meters

(N) Display Units

(O) Sensor Controllers

(P) Switching Mode Power Supplies

(Q) Stepper Motors & Drivers & Controllers

(R) Graphic/ Logic Panels

(S) Field Network Devices

(T) Software

MT4N Series

■ Connections

◎ Measuring input terminal connection

● MT4N-DV-□□

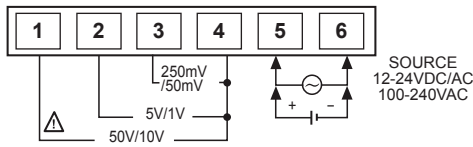

● MT4N-DA-□□

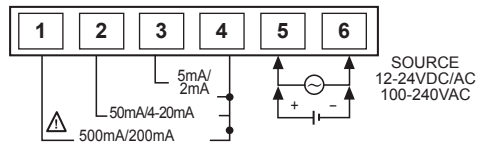

● MT4N-AV-□□

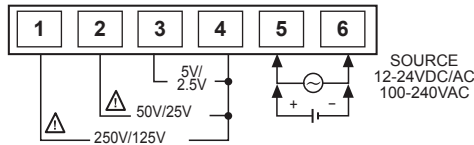

● MT4N-AA-□□

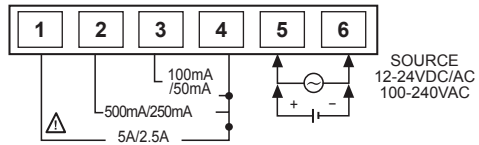

◎ Output terminal of connection

● MT4N-□□0 (Relay output)

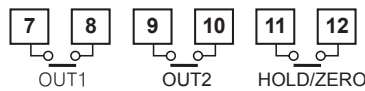

● MT4N-□□□ (NPN open collector output)

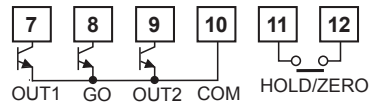

● MT4N-□□2 (PNP open collector output)

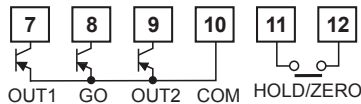

● MT4N-□□3 (Relay+transmission (DC4-20mA) output)

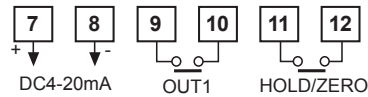

● MT4N-□□4 (Relay+RS485 communication output)

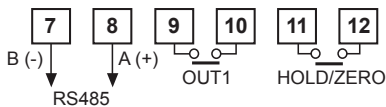

● MT4N-□□5 (Relay+transmission (DC4-20mA) output)

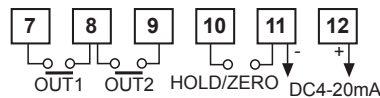

■ Parameter Setting

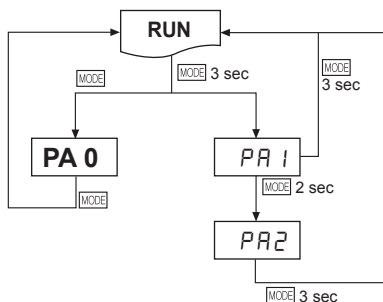

- ※ Press **[MODE]** key in **RUN** mode and it enters **PA 0** group.
- ※ Press **[MODE]** key for over 3 sec in **RUN** mode, it displays **[PA 1]**.
- ※ Press **[MODE]** key for over 5 sec in **RUN** mode, it displays **[PA 2]** after **[PA 1]**.
When pressing **[MODE]** key continually, it stops displaying at **[PA 2]**.
- ※ It is advanced to current display parameter releasing **[MODE]** key at **[PA 1]** or **[PA 2]**.
- ※ Press **[MODE]** key for over 3 sec in any parameter groups, it returns to **RUN** mode.
- ※ If any key is not entered for 60 sec in each parameter, it returns to **RUN** mode.
- ※ After returning to **RUN** mode, press **[MODE]** key within 2 sec, it returns to previous parameter. (Refer to descriptions of each parameter group.)
- ※ **PA 0** group cannot be entered when preset output mode of **[PA 2]** group is **OFF**.

Parameter 1 Group

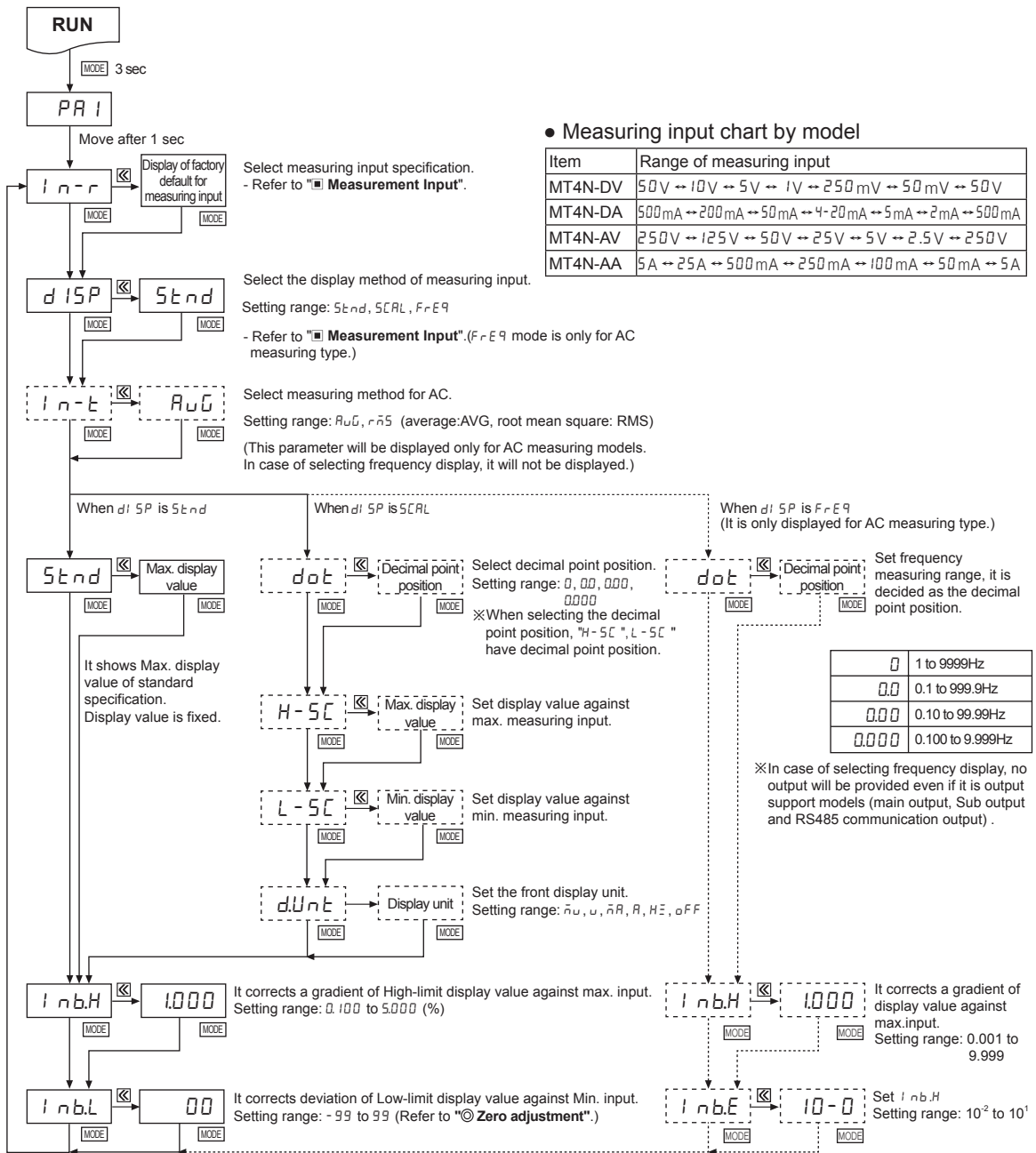

※After setting each mode, press **MODE** key for 2 sec to return to **RUN**.
 ※If any key is untouched for 60 sec after advance to Parameter, it will return to **RUN**.

Factory defaults

Parameter	MT4N-DV	MT4N-DA	MT4N-AV	MT4N-AA	Parameter	MT4N-DV	MT4N-DA	MT4N-AV	MT4N-AA
In-r	50	500	250	5	Inb.H	1.000	1.000	1.000	1.000
dISP	Stnd	Stnd	Stnd	Stnd	Inb.L	00	00	00	00
In-t	—	—	Avg	Avg	dot	000	00	00	0000
Stnd	5000	5000	2500	5000	Inb.E	—	—	10-0	10-0
dUnit	u	A	u	A					

- (A) Photoelectric Sensors
- (B) Fiber Optic Sensors
- (C) Door/Area Sensors
- (D) Proximity Sensors
- (E) Pressure Sensors
- (F) Rotary Encoders
- (G) Connectors/ Connector Cables/ Sensor Distribution Boxes/ Sockets
- (H) Temperature Controllers
- (I) SSRs / Power Controllers
- (J) Counters
- (K) Timers
- (L) Panel Meters
- (M) Tacho / Speed / Pulse Meters
- (N) Display Units
- (O) Sensor Controllers
- (P) Switching Mode Power Supplies
- (Q) Stepper Motors & Drivers & Controllers
- (R) Graphic/ Logic Panels
- (S) Field Network Devices
- (T) Software

MT4N Series

Parameter 2 Group

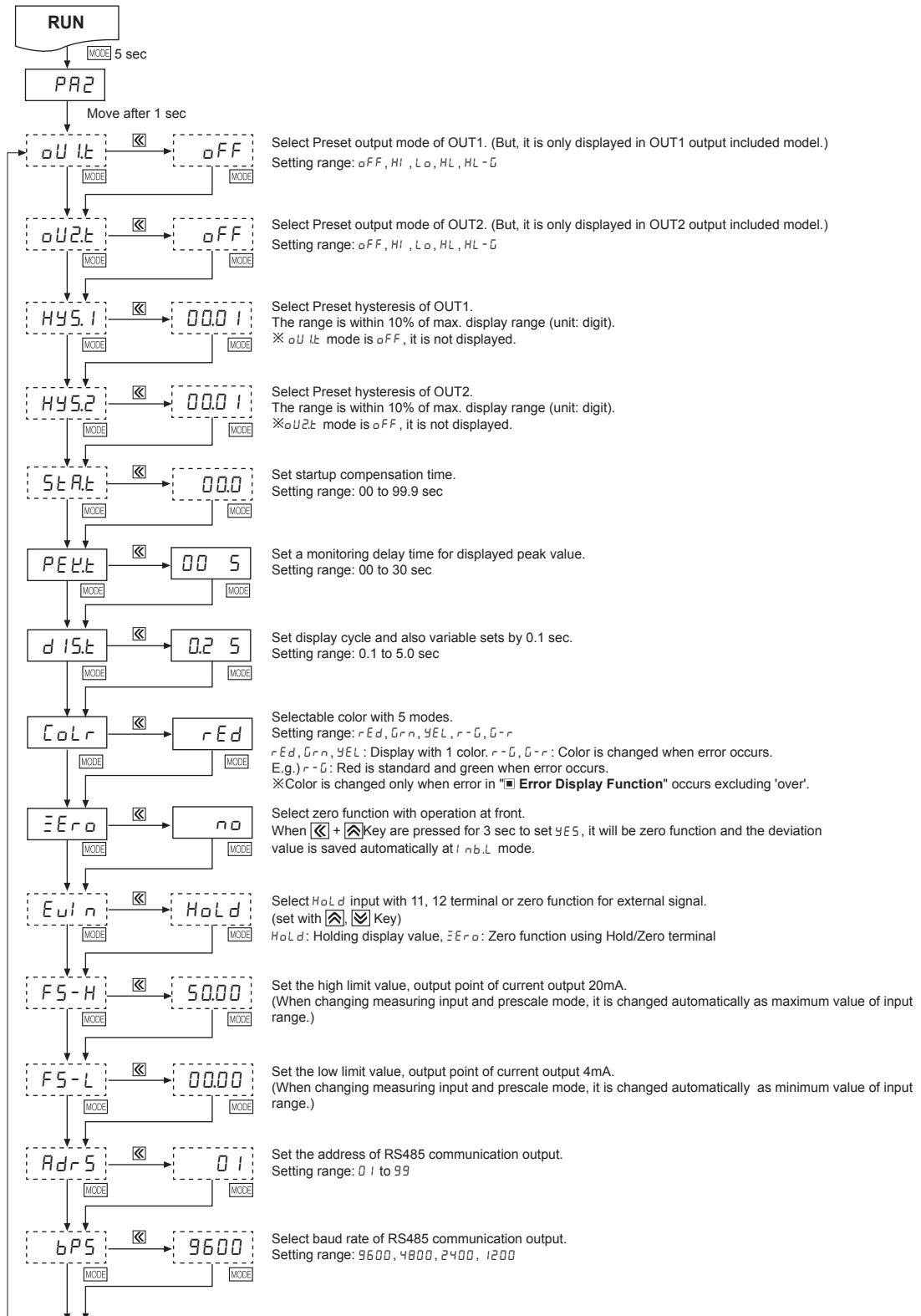

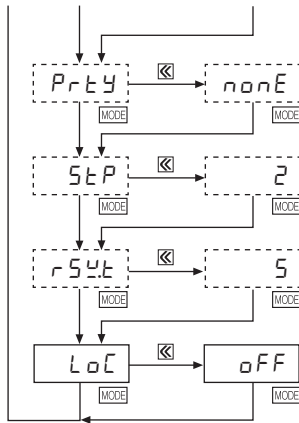

Set parity bit of RS485 communication.
Setting range: nonE, EuEn, odd

Set stop bit of RS485 communication.
Setting range: 1, 2

Set response wait time of RS485 communication.
Setting range: 5 to 99

Set key lock function and select from 4 types.
Setting range: oFF, LoC1, LoC2, LoC3

oFF	Disable to lock keys
LoC1	Lock Parameter 1
LoC2	Lock Parameter 1, 2
LoC3	Lock Parameter 0, 1 and 2

※The dotted mode is only displayed for output type.

※After setting each mode, press **MODE** key for 2 sec to return to **RUN** mode.

※If any key is untouched for 60 sec after advance to parameter, it will return to **RUN** mode.

※The min. setting interval between F5-H and F5-L is 10% F.S., it is fixed as 10% of the setting value when it is small.

◎ Factory defaults

Parameter	MT4N-DV	MT4N-DA	MT4N-AV	MT4N-AA	Parameter	MT4N-DV	MT4N-DA	MT4N-AV	MT4N-AA
oUIt	oFF	oFF	oFF	oFF	Err	no	no	no	no
oU2t	oFF	oFF	oFF	oFF	Ein	Hold	Hold	Hold	Hold
HYS1	0001	0001	0001	0001	F5-H	5000	5000	2500	5000
HYS2	0001	0001	0001	0001	F5-L	0000	0000	00	0000
PEt	005	005	005	005	AdrS	01	01	01	01
dISt	025	025	025	025	bPS	9600	9600	9600	9600
CoLr	rEd	rEd	rEd	rEd	LoC	oFF	oFF	oFF	oFF

■ Parameter 0 Group

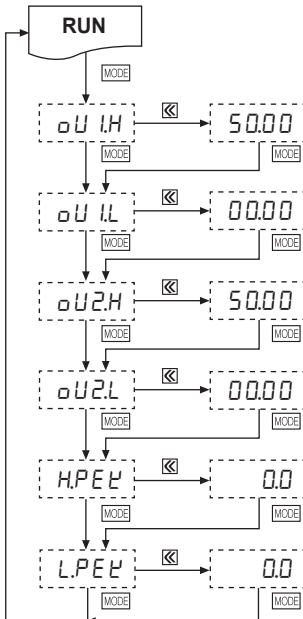

Set High-limit preset value of oU1H. (set with **◀**, **▶**, **✓** key)

※It is displayed when set the preset only.

When set oFF in oUIt mode if **PA 2**, the parameter is not displayed.

Set Low-limit preset value of oU1L. (set with **◀**, **▶**, **✓** key)

※It is displayed when set the preset only.

When set oFF in oUIt mode if **PA 2**, the parameter is not displayed.

Set High-limit preset value of oU2H. (set with **◀**, **▶**, **✓** key)

※It is displayed when set the preset only.

When set oFF in oU2t mode if **PA 2**, the parameter is not displayed.

Set Low-limit preset value of oU2L. (set with **◀**, **▶**, **✓** key)

※It is displayed when set the preset only.

When set oFF in oU2t mode if **PA 2**, the parameter is not displayed.

It shows High-limit monitoring value while it is **RUN** status.

It will be reset by pressing any **◀**, **▶**, **✓** key.

※HPEt parameter is not displayed when PEt parameter is set as 00 sec [00 5] at **PA 2**.

It shows Low-limit monitoring value while it is **RUN** status.

It will be reset by pressing any **◀**, **▶**, **✓** key.

※LPEt parameter is not displayed when PEt parameter is set as 00 sec [00 5] at **PA 2**.

※If any key is untouched for 60 sec after advance to parameter, it will return to **RUN** mode.

◎ Factory defaults

Parameter	MT4N-DV	MT4N-DA	MT4N-AV	MT4N-AA	Parameter	MT4N-DV	MT4N-DA	MT4N-AV	MT4N-AA
oU1H	5000	5000	2500	5000	oU2L	0000	0000	0000	0000
oU1L	0000	0000	0000	0000	HPEt	000	00	00	0000
oU2H	5000	5000	2500	5000	LPEt	000	00	00	0000

- (A) Photoelectric Sensors
- (B) Fiber Optic Sensors
- (C) Door/Area Sensors
- (D) Proximity Sensors
- (E) Pressure Sensors
- (F) Rotary Encoders
- (G) Connectors/ Connector Cables/ Sensor Distribution Boxes/ Sockets
- (H) Temperature Controllers
- (I) SSRs / Power Controllers
- (J) Counters
- (K) Timers
- (L) Panel Meters
- (M) Tacho / Speed / Pulse Meters
- (N) Display Units
- (O) Sensor Controllers
- (P) Switching Mode Power Supplies
- (Q) Stepper Motors & Drivers & Controllers
- (R) Graphic/ Logic Panels
- (S) Field Network Devices
- (T) Software

MT4N Series

■ Measurement Input

Type	Measuring input and range	Input impedance	Display range [5 t n d]	Prescale display range [5 C R L]										
DC voltage	0-50V [5 0 V]	434.35kΩ	0.00 to 50.00 (fixed)	<table border="1"> <thead> <tr> <th>d o t</th> <th>Display range</th> </tr> </thead> <tbody> <tr> <td>0</td> <td>-1999 to 9999</td> </tr> <tr> <td>0.0</td> <td>-199.9 to 999.9</td> </tr> <tr> <td>0.00</td> <td>-19.99 to 99.99</td> </tr> <tr> <td>0.000</td> <td>-1.999 to 9.999</td> </tr> </tbody> </table> <p>(Display range is variable according to decimal point position.)</p>	d o t	Display range	0	-1999 to 9999	0.0	-199.9 to 999.9	0.00	-19.99 to 99.99	0.000	-1.999 to 9.999
	d o t	Display range												
	0	-1999 to 9999												
	0.0	-199.9 to 999.9												
	0.00	-19.99 to 99.99												
	0.000	-1.999 to 9.999												
0-10V [1 0 V]	434.35kΩ	0.00 to 10.00 (fixed)												
0-5V [5 V]	43.35kΩ	0.000 to 5.000 (fixed)												
0-1V [1 V]	43.35kΩ	0.000 to 1.000 (fixed)												
0-250mV [2 5 0 m V]	2.15kΩ	0.0 to 250.0 (fixed)												
0-50mV [5 0 m V]	2.15kΩ	0.00 to 50.00 (fixed)												
DC current	0-500mA [5 0 0 m A]	0.1Ω	0.0 to 500.0 (fixed)	<p>※Please wire the proper terminal to its max. input within 30 to 100% of the input terminal. When it is higher than input, it may cause terminal breakdown and HHHH appears. The accuracy is decreased when it is connected to the terminal under 30%.</p>										
	0-200mA [2 0 0 m A]	0.1Ω	0.0 to 200.0 (fixed)											
	0-50mA [5 0 m A]	1.1Ω	0.00 to 50.00 (fixed)											
	4-20mA [4 - 2 0 m A]	1.1Ω	4.00 to 20.00 (fixed)											
	0-5mA [5 m A]	101.1Ω	0.000 to 5.000 (fixed)											
	0-2mA [2 m A]	101.1Ω	0.000 to 2.000 (fixed)											
AC voltage	0-250V [2 5 0 V]	1.109MΩ	0.0 to 250.0 (fixed)											
	0-125V [1 2 5 V]	1.109MΩ	0.0 to 125.0 (fixed)											
	0-50V [5 0 V]	200kΩ	0.00 to 50.00 (fixed)											
	0-25V [2 5 V]	222kΩ	0.00 to 25.00 (fixed)											
	0-5V [5 V]	22kΩ	0.000 to 5.000 (fixed)											
	0-2.5V [2 . 5 V]	22kΩ	0.000 to 2.500 (fixed)											
AC current	0-5A [5 A]	0.01Ω	0.000 to 5.000 (fixed)											
	0-2.5A [2 . 5 A]	0.01Ω	0.000 to 2.500 (fixed)											
	0-500mA [5 0 0 m A]	0.1Ω	0.0 to 500.0 (fixed)											
	0-250mA [2 5 0 m A]	0.1Ω	0.0 to 250.0 (fixed)											
	0-100mA [1 0 0 m A]	0.5Ω	0.0 to 100.0 (fixed)											
	0-50mA [5 0 m A]	0.5Ω	0.00 to 50.00 (fixed)											

■ Sold Separately

◎ Communication converter

- **SCM-WF48**
(Wi-Fi to RS485-USB wireless communication converter)



- **SCM-US48I**
(USB to RS485 converter)



- **SCM-38I**
(RS232C to RS485 converter)



◎ Display Units (DS/DA-T Series)

- **DS/DA-T Series**
(RS485 communication input type display unit) CE



DS16-□T



DS22/DA22-□T



DS40/DA40-□T



DS60/DA60-□T

※Connect RS485 communication input type display unit (DS/DA-T Series) and RS485 communication output model of MT4N Series, the display unit displays present value of the device without PC/PLC.

■ Functions

◎ AC frequency measurement

[PA1 group: $d15P$]

It measures input signal frequency when it is AC input. It uses fixed decimal point [PA1: $d0E$], measured range can be changed by setting and measured range of decimal point position is as below chart. It is available to adjust the upper gradient at [PA1: $i nbH$] and [PA1: $i nbE$]. In order to measure frequency normally, input signal, over 10% F.S. of the measured range, should be supplied. Please select the proper point of measurement terminal.

① Measuring range

Decimal point position	0.000	0.00	0.0	0
Decimal point position	0.100 to 9.999Hz	0.10 to 99.99Hz	0.1 to 999.9Hz	1 to 9999Hz

※Accuracy of frequency measurement:

Below 1kHz, F.S. $\pm 0.1rdg \pm 2$ -digit.

From 1kHz to 10kHz, F.S. $\pm 0.3rdg \pm 2$ -digit.

② $i nbH$: 0.100 to 9.999

[Gradient adjustment of high value]

③ $i nbE$: 10^{-2} , 10^{-1} , 10^0 , 10^1 [Index adjustment of $i nbH$]

◎ Zero adjustment

[Deviation correction function of low limit display value]

It adjusts the display value of the optional configured input value as zero by force, zero point error can be adjusted with 3 ways as below. When zero point adjustment with front key and Hold terminal is finished normally, zero point of measurement terminal is displayed and the adjusted value at saved in $i nbL$ automatically.

Operation	Input correction value	Front panel key	Input external signal
Description	PA1: Direct input correction value method at $i nbL$	$\left[\text{Key 1} \right]$, $\left[\text{Key 2} \right]$ keys are pressed for 3 sec at the RUN mode.	Short-circuit External hold terminal 11, 12 over min. 50m.

※Refer to "◎ Error correction", "◎ Error display" and "■ Parameter 2 Group" for function and error.

◎ Transmission (DC4-20mA) output scale [PA2 group: $F5-H / F5-L$]

It sets transmission output for the display value at the output current DC4-20mA.

It sets display value for 4mA at $F5-L$ and 20mA at $F5-H$ and the range between $F5-H$ and $F5-L$ should be 10%

※When min. set interval between $F5-H$ and $F5-L$ is set as under 10% F.S., it changed as over 10% F.S. automatically.

※Preset display value is fixed to output as 4mA at under $F5-L$ and 20mA at over $F5-H$.

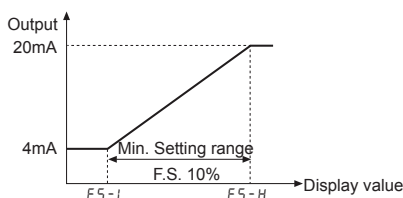

◎ Initialization

It initializes as the factory default status. If press $\left[\text{Key 1} \right]$, $\left[\text{Key 2} \right]$, $\left[\text{Key 3} \right]$ keys together for 2 sec in RUN mode, $i nbL$ mode and the setting value [n0] is displayed every 0.5 sec and it will be initialized as the factory default when press $\left[\text{MODE} \right]$ key after change $n0 \rightarrow 4E5$.

◎ Error display

Display	Description
HHHH	Flashes when measuring input is exceeded the max. allowable input (110%)
LLLL	Flashes when measuring input is exceeded the max. allowable input (-10%)
d-HH	Flashes when display input is exceeded max. display range (9999)
d-LL	Flashes when measuring input is exceeded min. display range (-1999)
F-HH	Flashes when measuring frequency is exceeded the max. measuring value (9999)
00Er	Flashes when it exceeds zero adjustment range (± 99)

※Error display is released automatically when it is in the measured and display range.

※"LLLL" is displayed when the measuring input is DC4-20mA.

※After flashing "00Er" 2 times when it exceeds the zero adjustment range, it returns to RUN mode.

◎ Display scale [PA1 group: $H-5C / L-5C$]

This function is to display setting (-1999 to 9999) of particular High/Low-limit value in order to display High/Low-limit value of measured input. If measured inputs are 'a' and 'b' and particular values are 'A' and 'B', it will display $a=A$, $b=B$ as below graphs.

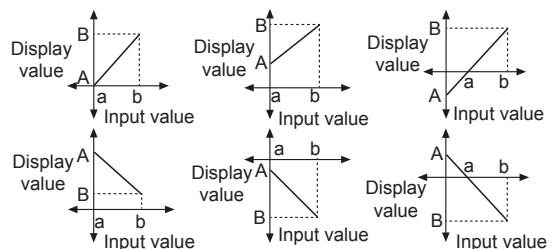

(A)	Photoelectric Sensors
(B)	Fiber Optic Sensors
(C)	Door/Area Sensors
(D)	Proximity Sensors
(E)	Pressure Sensors
(F)	Rotary Encoders
(G)	Connectors/ Connector Cables/ Sensor Distribution Boxes/ Sockets
(H)	Temperature Controllers
(I)	SSRs / Power Controllers
(J)	Counters
(K)	Timers
(L)	Panel Meters
(M)	Tacho / Speed / Pulse Meters
(N)	Display Units
(O)	Sensor Controllers
(P)	Switching Mode Power Supplies
(Q)	Stepper Motors & Drivers & Controllers
(R)	Graphic/ Logic Panels
(S)	Field Network Devices
(T)	Software

◎ Gradient correction [PA1 group: $i_{nb.H}$]

It corrects the gradient of prescale value and display value. (Fig. 1) Display value Y can be adjusted as α , β times against X input value by correction function [$i_{nb.H}$] and used as correction function of max. display value [H-5C]. Adjustment range is 0.100 to 5.000 and multiply current gradient.

E.g.) To display "3.000" in DC 200mV input for measured input specification as 0 to 1V.

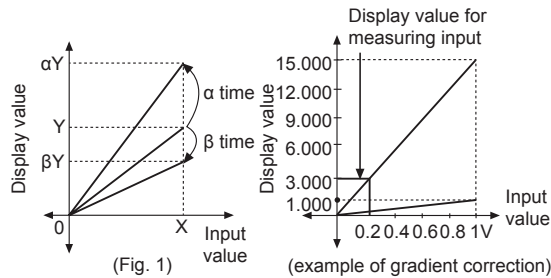

- ① Select 0-1VDC[i_{L}] for measured input in Parameter 1.
- ② Standard specification in input: 0-1VDC and 1.000 therefore it has to be 15.000[H-5C] for 1VDC (input) in order to display 3.000 for 200mVDC (input). But it is unable due to setting range is 9.999.
- ③ In this case, please check below chart. Please set as $i_{nb.H} \times H-5C = 15.000$

Setting	H-5C	L-5C	$i_{nb.H}$	Note
①	Disable	0.000	1.000	—
②	7.500	0.000	2.000	In this case, any setting methods display the same display value.
③	5.000	0.000	3.000	
④	3.750	0.000	4.000	
⑤	3.000	0.000	5.000	

◎ Error correction [PA 1 group: $i_{nb.L}$ / $i_{nb.L}$]

It corrects display value error of measured input.

$i_{nb.L}$: ± 99 [Adjust deviation of low value]

$i_{nb.H}$: 5.000 to 0.100 [Correct gradient (%) of high value]

Display value = (measured value $\times i_{nb.H}$) + $i_{nb.L}$

E.g.) When the measured range is 0 to 500V, and the display range is 0 to 500.0. If the low display value is "1.2" to 0V input, set -12 as $i_{nb.L}$ value to display "0.0" by adjusting offset of the low value. The display value to 500V measured input varies by adjusting the offset of low value. If this display value is "501.0", calculate $500.0/501.0$ (desired display value/the display value), and set the 0.998 correction value as the $i_{nb.H}$ to display 500.0 by adjusting gradient of high value.

※ The offset correction range of $i_{nb.L}$ is within -99 to 99 for D^0 , D^{-1} digit regardless of decimal point.

◎ Display cycle delay [PA 2 group: $d_{i.5t}$]

In some applications the measured input may fluctuate which in turn causes the display to fluctuate. By adjusting the display cycle delay function time in the $d_{i.5t}$ of parameter 2, the operator can adjust the display time within a range of 0.1 sec to 5 sec. For example, if the operator sets the display cycle time to 4.0 sec, the display value displayed will be the average input value over 4 sec and also will show any changes if any every 4 sec.

◎ Monitoring peak display value

[PA 0 group: $HPEL$ / $LPEL$, PA 2 group: $PEEL$]

It monitors max./min. value of display value based on the current displays value and then displays the data at $HPEL$, $LPEL$ of parameter 0. Set the delay time (0 to 30 sec) at $PEEL$ of parameter 2 in order to prevent malfunction caused by initial overcurrent or overvoltage, when monitoring the peak value.

Delay time is 0 to 30 sec and it starts to monitor the peak value after the set time. When pressing any one of \leftarrow \rightarrow \uparrow \downarrow keys at $HPEL$, $LPEL$ of parameter 0, the monitored data is initialized.

※ $HPEL$, $LPEL$ parameters are not displayed when monitoring delay time [$PEEL$] of parameter 2 group is set as 00 sec [00 5].

◎ Preset output operation mode

[PA 2 group: $o_{U.Lt}$ / $o_{U.2t}$]

Mode	Output operation	Operation
o_{FF}		No output
Hl		Period ON : Display value \geq OUT.H Period OFF : Display value \leq OUT.H-Hys
Lo		Period ON : Display value \leq OUT.L Period OFF : Display value \geq OUT.L+Hys
Hl		Period ON : Display value \leq OUT.L or Display value \geq OUT.H Period OFF : Display value \geq OUT.L +Hys or Display value \leq OUT.H-Hys
$Hl - G$		Period ON : OUT.L \leq Display value \leq OUT.H+Hys Period OFF : Display value \leq OUT.L -Hys or Display value \geq OUT.H+Hys

※ Set output mode separately for each OUT1/OUT2.

※ OUT1/OUT2 are operated individually depending on output operation mode.

※ Setting value mode of parameter group 0 is displayed by output operation mode selection.

※ GO is outputted within the period both OUT1/OUT2 are off. (NPN/PNP open collector output type.)

■ Communication Output

(refer to pages L-46 to L-47.)